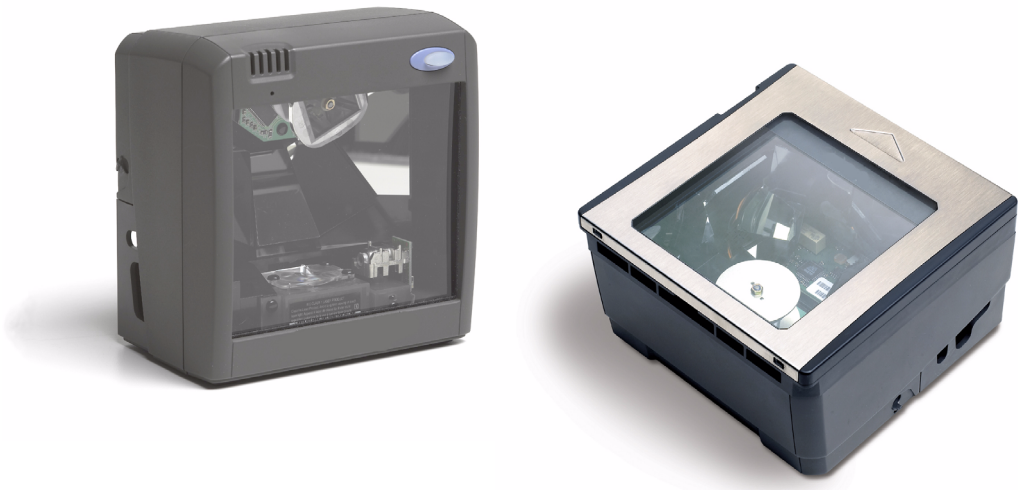




Magellan[®] 2200VS/2200VS and 2300HS/2300HS

Enhanced



Product Reference Guide

Datalogic Scanning, Inc.

959 Terry Street
Eugene, Oregon 97402
Telephone: (541) 683-5700
Fax: (541) 345-7140

An Unpublished Work - All rights reserved. No part of the contents of this documentation or the procedures described therein may be reproduced or transmitted in any form or by any means without prior written permission of Datalogic Scanning, Inc. or its subsidiaries or affiliates ("Datalogic" or "Datalogic Scanning"). Owners of Datalogic products are hereby granted a non-exclusive, revocable license to reproduce and transmit this documentation for the purchaser's own internal business purposes. Purchaser shall not remove or alter any proprietary notices, including copyright notices, contained in this documentation and shall ensure that all notices appear on any reproductions of the documentation.

Should future revisions of this manual be published, you can acquire printed versions by contacting your Datalogic representative. Electronic versions may either be downloadable from the Datalogic website (www.scanning.datalogic.com) or provided on appropriate media. If you visit our website and would like to make comments or suggestions about this or other Datalogic publications, please let us know via the "Contact Datalogic" page.

Disclaimer

Datalogic has taken reasonable measures to provide information in this manual that is complete and accurate, however, Datalogic reserves the right to change any specification at any time without prior notice.

Datalogic is a registered trademark of Datalogic S.p.A. in many countries and the Datalogic logo is a trademark of Datalogic S.p.A. All other brand and product names referred to herein may be trademarks of their respective owners.

Magellan, FirstStrike and SurroundScan are registered trademarks of Datalogic Scanning, Inc. All-Weighs, OmegaTek, Produce Rail, Productivity Index Reporting, SmartSentry and Any-Weighs are all trademarks of Datalogic Scanning, Inc.

This product may be covered by one or more of the following patents: 4603262 • 4639606 • 4652750 • 4672215 • 4699447 • 4709369 • 4749879 • 4786798 • 4792666 • 4794240 • 4798943 • 4799164 • 4820911 • 4845349 • 4861972 • 4861973 • 4866257 • 4868836 • 4879456 • 4939355 • 4939356 • 4943127 • 4963719 • 4971176 • 4971177 • 4991692 • 5001406 • 5015831 • 5019697 • 5019698 • 5086879 • 5115120 • 5144118 • 5146463 • 5179270 • 5198649 • 5200597 • 5202784 • 5208449 • 5210397 • 5212371 • 5212372 • 5214270 • 5229590 • 5231293 • 5232185 • 5233169 • 5235168 • 5237161 • 5237162 • 5239165 • 5247161 • 5256864 • 5258604 • 5258699 • 5260554 • 5274219 • 5296689 • 5298728 • 5311000 • 5327451 • 5329103 • 5330370 • 5347113 • 5347121 • 5371361 • 5382783 • 5386105 • 5389917 • 5410108 • 5420410 • 5422472 • 5426507 • 5438187 • 5440110 • 5440111 • 5446271 • 5446749 • 5448050 • 5463211 • 5475206 • 5475207 • 5479011 • 5481098 • 5491328 • 5493108 • 5504350 • 5508505 • 5512740 • 5541397 • 5552593 • 5557095 • 5563402 • 5565668 • 5576531 • 5581707 • 5594231 • 5594441 • 5598070 • 5602376 • 5608201 • 5608399 • 5612529 • 5629510 • 5635699 • 5641958 • 5646391 • 5661435 • 5664231 • 5666045 • 5671374 • 5675138 • 5682028 • 5686716 • 5696370 • 5703347 • 5705802 • 5714750 • 5717194 • 5723852 • 5750976 • 5767502 • 5770847 • 5786581 • 5786585 • 5787103 • 5789732 • 5796222 • 5804809 • 5814803 • 5814804 • 5821721 • 5822343 • 5825009 • 5834708 • 5834750 • 5837983 • 5837988 • 5852286 • 5864129 • 5869827 • 5874722 • 5883370 • 5905249 • 5907147 • 5923023 • 5925868 • 5929421 • 5945670 • 5959284 • 5962838 • 5979769 • 6000619 • 6006991 • 6012639 • 6016135 • 6024284 • 6041374 • 6042012 • 6045044 • 6047889 • 6047894 • 6056198 • 6065676 • 6069696 • 6073849 • 6073851 • 6094288 • 6112993 • 6129279 • 6129282 • 6134039 • 6142376 • 6152368 • 6152372 • 6155488 • 6166375 • 6169614 • 6173894 • 6176429 • 6188500 • 6189784 • 6213397 • 6223986 • 6230975 • 6230976 • 6244510 • 6259545 • 6260763 • 6266175 • 6273336 • 6276605 • 6279829 • 6290134 • 6290135 • 6293467 • 6303927 • 6311895 • 6318634 • 6328216 • 6332576 • 6332577 • 6343741 • 6454168 • 6478224 • 6568598 • 6578765 • 6705527 • 6857567 • 6974084 • 6991169 • 7051940 • 7170414 • 7172123 • 7201322 • 7204422 • 7215493 • 7224540 • 7234641 • 7243850 • 7374092 • 601 26 118.6 • AU703547 • D312631 • D313590 • D320011 • D320012 • D323492 • D330707 • D330708 • D349109 • D350127 • D350735 • D351149 • D351150 • D352936 • D352937 • D352938 • D352939 • D358588 • D361565 • D372234 • D374630 • D374869 • D375493 • D376357 • D377345 • D377346 • D377347 • D377348 • D388075 • D446524 • EP0256296 • EP0260155 • EP0260156 • EP0295936 • EP0325469 • EP0349770 • EP0368254 • EP0442215 • EP0498366 • EP0531645 • EP0663643 • EP0698251 • EP01330772 • GB2252333 • GB2284086 • GB2301691 • GB2304954 • GB2307093 • GB2308267 • GB2308678 • GB2319103 • GB2333163 • GB2343079 • GB2344486 • GB2345568 • GB2354340 • ISR107546 • ISR118507 • ISR118508 • JP1962823 • JP1971216 • JP2513442 • JP2732459 • JP2829331 • JP2953593 • JP2964278 • MEX185552 • MEX187245 • RE37166 • RE40.071 • Other Patents Pending

Chapter 1. Introduction	1-1
Manual Overview	1-1
How to Use This Manual	1-2
Scanner Nomenclature	1-3
Connectors	1-4
Physical Parameters	1-5
Scanning	1-5
AC Adapter	1-5
Electrical Specifications	1-6
Laser and Product Safety	1-8
Labeling	1-10
Agency Compliances	1-12
Bar Codes Supported	1-13
Retail Codes	1-13
Industrial Codes	1-13
Dual Bar Codes for Japan (2 label read)	1-14
 Chapter 2. Site Preparation and Installation.....	 2-15
Unpacking	2-15
Operational Verification	2-16
Installation: Model 2200VS	2-17
Installation: Model 2300HS	2-20
 Chapter 3. Operation and Maintenance.....	 3-23
Scanning Items: Model 2200VS	3-24
Scanning Items: Model 2300HS	3-25
Operational Controls	3-26
Operational Modes	3-26
Power-Up/Selftest & Pre-Operation	3-26
Operating Mode	3-27
Additional Functions	3-29
Programming	3-29
Scanner Diagnostic Mode	3-29
Scanner Reset	3-30
Operational Maintenance	3-30
Cleaning	3-30
 Chapter 4. Problem Isolation.....	 4-31
Diagnostic Procedures	4-32
Error Codes	4-33
Flowcharts	4-34
 Chapter 5. Programming.....	 5-39
Introduction to Label Programming	5-39
Understanding the Basics	5-39
Integrating the Scanner With Your Host System	5-40

Customizing Your Scanner's Operation	5-40
Programming Overview	5-42
Programming via Handheld Device	5-42
What Is Programming Mode?	5-43
Entering and Exiting Programming Mode.	5-43
Programming Session	5-44
LED and Beeper Indicators	5-48
If You Make a Mistake... ..	5-48
Return to Factory Settings	5-48
Test Mode	5-49
General Scanner Features	5-50
Scanner Button Options	5-50
Double Read Timeout	5-52
Laser Timeout	5-54
Motor Timeout	5-56
Label Gone Timeout	5-59
Auxiliary Port Mode	5-62
Auxiliary Port Baud Rate	5-64
Productivity Index Reporting (PIR)/Cashier Training (CT)	5-68
Indication Features	5-69
Green LED Idle State	5-69
Power-up Beep Control	5-70
Good Read Beep Control	5-71
Good Read Beep Frequency	5-72
Good Read Beep Length	5-74
Good Read Beep Volume	5-75
Good Read When to Indicate	5-78
EAS Features	5-80
EAS Active State	5-80
EAS Timeout	5-81
Interface Related Features	5-82
Interface Type	5-82
Maximum Host-Transmitted Message Length	5-103
Number of Host Transmission Buffers	5-104
AIM ID	5-105
Label ID Control	5-107
Global Prefix	5-110
Global Suffix	5-112
Case Conversion	5-114
IBM Features	5-116
IBM Interface Options	5-116
IBM Number of Host Resets	5-117
IBM Transmit Labels in Code 39 Format	5-118
IBM Label Slicing Control	5-119
IBM Maximum Label Slice Length	5-120
USB-OEM Scanner Device Type	5-121
RS-232 Features	5-122

RS-232 Baud Rate	5-122
RS-232 Number of Data Bits	5-126
RS-232 Number of Stop Bits	5-127
RS-232 Parity	5-128
RS-232 Hardware Control	5-130
RS-232 Intercharacter Delay	5-133
RS-232 Software Flow Control	5-134
RS-232 Host Echo	5-135
RS-232 Host Echo Quiet Interval	5-136
RS-232 Ignore Host Commands	5-137
RS-232 TTL	5-138
RS-232 TTL Invert	5-139
RS-232 ICL DC1 Character Delay Enable	5-140
RS-232 Beep on ASCII BEL	5-141
RS-232 Beep on Not on File	5-142
RS-232 ACK NAK Enable	5-143
RS-232 ACK Character	5-145
RS-232 NAK Character	5-146
RS-232 Retry on ACK NAK Timeout	5-147
RS-232 ACK NAK Timeout Value	5-148
RS-232 ACK NAK Retry Count	5-149
RS-232 ACK NAK Error Handling	5-150
RS-232 Indicate Transmission Failure	5-152
Single Cable RS-232 Options	5-153
Single Cable Pacesetter Plus Enable	5-154
Single Cable RS-232 RTS CTS Selection	5-155
Single Cable RS-232 Use BCC	5-158
Single Cable RS-232 Use ACK/NAK	5-159
Single Cable RS-232 Use STX	5-160
Set Single Cable RS-232 STX Character	5-161
Set Single Cable RS-232 ETX Character	5-162
Keyboard Wedge/USB Keyboard Features	5-163
Keyboard Interface — Keyboard Layout	5-163
Keyboard Interface Quiet Interval	5-172
Keyboard Interface Caps Lock State	5-173
Keyboard Interface — Keyboard Simulation	5-175
Keyboard Interface — Control Characters	5-176
Keyboard Interface — Intercharacter Delay	5-178
Symbology Programming	5-179
Coupon Control	5-179
UPC-A Enable	5-181
UPC-A Number System Character Transmission	5-182
UPC-A Check Character Transmission	5-183
Expand UPC-A to EAN-13	5-184
UPC-A Label ID	5-185
UPC-A 2-Digit Supplemental Label ID	5-186
UPC-A 5-Digit Supplemental Label ID	5-187

UPC-A 128 Supplemental Label ID	5-188
UPC-A Minimum Reads	5-189
UPC-E Enable	5-191
UPC-E Number System Character Transmission	5-192
UPC-E Check Character Transmission	5-193
Expand UPC-E to UPC-A	5-194
Expand UPC-E to EAN-13	5-195
UPC-E Label ID	5-196
UPC-E 2-Digit Supplemental Label ID	5-197
UPC-E 5-Digit Supplemental Label ID	5-198
UPC-E 128 Supplemental Label ID	5-199
UPC-E Minimum Reads	5-200
EAN-13 Enable	5-202
EAN-13 First Character Transmission	5-203
EAN-13 Check Character Transmission	5-204
EAN-13 ISBN Conversion Enable	5-205
EAN 13 Label ID	5-206
EAN-13 2-Digit Supplemental Label ID	5-207
EAN-13 5-Digit Supplemental Label ID	5-208
EAN-13 128 Supplemental Label ID	5-209
EAN-13 Minimum Reads	5-210
Bookland Label ID	5-212
EAN-8 Enable	5-213
EAN-8 Check Character Transmission	5-214
Expand EAN-8 to EAN-13	5-215
EAN-8/JAN-8 Guard Insertion	5-216
EAN-8/JAN-8 Guard Substitution	5-217
EAN-8/JAN-8 Both Guards Substitution	5-218
EAN-8 Stitch Exact Label Halves	5-219
EAN-8 Stitch Unlike Label Halves	5-220
EAN 8 Label ID	5-221
EAN-8 2-Digit Supplemental Label ID	5-222
EAN-8 5-Digit Supplemental Label ID	5-223
EAN-8 128 Supplemental Label ID	5-224
EAN-8 Decoding Levels	5-225
EAN-8 Minimum Reads	5-228
EAN-8 Minimum Segment Length	5-230
Other UPC/EAN Options	5-236
Price Weight Check	5-237
In-Store Label Minimum Reads	5-240
Enable EAN Two Label	5-242
EAN Two Label Combined Transmission	5-243
UPC/EAN Guard Insertion	5-244
UPC/EAN Stitch Exact Label Halves	5-245
UPC/EAN Stitch Unlike Label Halves	5-246
UPC/EAN Character Reconstruction	5-247
EAN Two Label Minimum Reads	5-248

UPC/EAN Correlation	5-250
UPC/EAN Minimum Segment Length	5-251
Addons	5-257
Addon Timer	5-261
2-Digit Add-ons Minimum Reads	5-262
5-Digit Add-ons Minimum Reads	5-264
Code 128 Add-ons Minimum Reads	5-266
GTIN Enable	5-268
GTIN Label ID	5-269
GTIN 2-Digit Supplemental Label ID	5-270
GTIN 5-Digit Supplemental Label ID	5-271
GTIN Code 128 Supplemental Label ID	5-272
DataBar Omnidirectional Enable	5-273
DataBar Omnidirectional/EAN-128 Emulation	5-274
DataBar Omnidirectional Label ID	5-275
DataBar Omnidirectional Minimum Reads	5-276
DataBar Expanded Enable	5-278
DataBar Expanded EAN-128 Emulation	5-279
DataBar Expanded Label ID	5-280
DataBar Expanded Length Control	5-281
DataBar Expanded Length 1	5-282
DataBar Expanded Length 2	5-283
DataBar Expanded Minimum Reads	5-284
Code 39 Enable	5-286
Code 39 Start Stop Character Transmission	5-287
Code 39 Check Character Calculation	5-288
Code 39 Check Character Transmission	5-289
Code 39 Full ASCII	5-290
Code 39 Label ID	5-291
Code 39 Require Quiet Zones	5-292
Code 39 Length Control	5-293
Code 39 Length 1	5-294
Code 39 Length 2	5-295
Code 39 Correlation	5-296
Code 39 Stitching	5-297
Code 39 Minimum Reads	5-298
Pharmacode 39 Enable	5-300
Pharmacode 39 Start Stop Character Transmission	5-301
Pharmacode 39 Check Character Transmission	5-302
Pharmacode 39 Label ID	5-303
Code 128 Enable	5-304
Code 128 Transmit Function Characters	5-305
Convert Code 128 to Code 39	5-306
Code 128 Label ID	5-307
Code 128 Length Control	5-308
Code 128 Length 1	5-309
Code 128 Length 2	5-310

Code 128 Correlation	5-311
Code 128 Stitching	5-312
Code 128 Minimum Reads	5-313
EAN-128 Enable	5-315
EAN-128 Label ID	5-316
Interleaved 2 of 5 (I 2 of 5) Enable	5-317
I 2 of 5 Check Character Calculation	5-318
I 2 of 5 Check Character Transmission	5-319
I 2 of 5 Label ID	5-320
I 2 of 5 Length Control	5-321
I 2 of 5 Length 1	5-322
I 2 of 5 Length 2	5-323
I 2 of 5 Correlation	5-324
I 2 of 5 Stitching	5-325
I 2 of 5 Minimum Reads	5-326
Standard 2 of 5 (Std 2 of 5) Enable	5-328
Standard 2 of 5 Check Character Calculation	5-329
Standard 2 of 5 Check Character Transmission	5-330
Standard 2 of 5 Label ID	5-331
Standard 2 of 5 Length Control	5-332
Standard 2 of 5 Length 1	5-333
Standard 2 of 5 Length 2	5-334
Standard 2 of 5 Correlation	5-335
Standard 2 of 5 Stitching	5-336
Standard 2 of 5 Minimum Reads	5-337
Codabar Enable	5-339
Codabar Start Stop Character Transmission	5-340
Codabar Start Stop Character Set	5-341
Codabar Start Stop Character Match	5-343
Codabar Check Character Calculation	5-344
Codabar Check Character Transmission	5-345
Codabar Label ID	5-346
Codabar Require Quiet Zones	5-347
Codabar Length Control	5-348
Codabar Length 1	5-349
Codabar Length 2	5-350
Codabar Correlation	5-351
Codabar Stitching	5-352
Codabar Minimum Reads	5-353
Code 93 Enable	5-355
Code 93 Label ID	5-356
Code 93 Length Control	5-357
Code 93 Length 1	5-358
Code 93 Length 2	5-359
Code 93 Correlation	5-360
Code 93 Stitching	5-361
Code 93 Minimum Reads	5-362

MSI/Plessey Enable	5-364
MSI/Plessey Check Character Calculation	5-365
MSI/Plessey Number of Check Characters	5-366
MSI/Plessey Check Character Transmission	5-367
MSI/Plessey Label ID	5-368
MSI/Plessey Length Control	5-369
MSI/Plessey Length 1	5-370
MSI/Plessey Length 2	5-371
MSI/Plessey Correlation	5-372
MSI/Plessey Stitching	5-373
MSI/Plessey Minimum Reads	5-374
Appendix A. LED/Beeper Indications & Controls	A-377
Volume/Tone Push Button	A-378
Green LED Indicator	A-379
Appendix B. Cable Information.....	B-381
Appendix C. Keypad.....	C-383
Appendix D. Host Commands.....	D-391
Appendix E. Handheld Data Format Requirements	E-393
Handheld Data Format Requirements General	E-393
Datalogic Handheld Data Format Requirements	E-394
AIM Formats	E-402
Appendix F. Keyboard Function Key Mappings.....	F-409
Keyboard Model Cross Reference	F-409

NOTES

Chapter 1

Introduction

This Product Reference Guide contains comprehensive instructions on how to install the scanner, how to program it using special programming feature bar code labels, and advanced user information as described in the following overview.

Manual Overview

Chapter 1, Introduction, presents the manual's contents, describes features and specifications, provides regulatory and safety information, and lists the bar code symbologies the scanner will read.

Chapter 2, Site Preparation and Installation, supplies physical dimensions for the scanner and its most common accessories, and details counter preparation and installation. Cable routing, connection and testing are also explained in this section.

Chapter 3, Operation and Maintenance, describes use and maintenance; providing details about operator controls, programming and diagnostic modes. Scanner routine maintenance is outlined in this section as well.

Chapter 4, Problem Isolation, provides an outline of three scanner test modes: Selftest, Operational Tests and Diagnostic Tests. Descriptions of the error indications if the scanner detects a system problem and troubleshooting flowcharts to aid in problem resolution are also presented.

Chapter 5, Programming, details procedures and provides custom bar-codes for setting programmable scanner features. This section is organized by the categories: General Features, Interface Related Features and Symbology Related Features.

Appendix A, LED/Beeper Indications & Controls, lists the various functions and indications of the scanner control panel features.

Appendix B, Cable Information, outlines wire requirements, connector specifications and pinout details for associated product cabling.

Appendix C, Keypad, furnishes bar codes representing the digits and characters required to enter extended programming data needed during certain programming sessions.

Appendix D, Host Commands, contains a partial listing of available host commands that can be used with a compatible host interface.




Appendix E, Factory Defaults, is a listing of standard factory defaults for the various programmable features.

Appendix E, Handheld Data Format Requirements, provides application notes to describe the general format of data that can be accepted by the scanner through the auxiliary port as transmitted from a handheld scanner.

How to Use This Manual

You'll find it helpful to familiarize yourself with the first section of this manual, since it provides both a general description of the product's features and an overview of the manual's contents and organization. Reference the other sections as required for information about scanner installation, operation, maintenance and bar code programming.

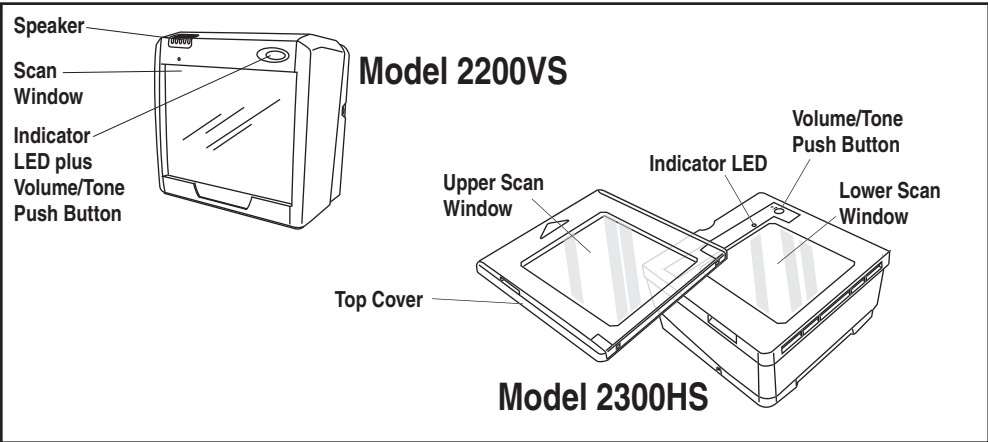
Manual Conventions

	<p>'NOTE' blocks contain information that is helpful and recommended. They provide information that is critical to operations and/or procedures described in this manual.</p>
	<p>'CAUTION' blocks inform you that proper handling (adherence to the procedures described) is required to avoid damage to equipment and/or property.</p>
	<p>'WARNING' blocks alert you to potential physical harm or injury. These statements do not include potentially fatal hazards, which would be designated as 'DANGER' blocks. Use of this product does not warrant the need for a DANGER block.</p>

Scanner Nomenclature

Controls, indicators and other nomenclature are shown in [Figure 1-1](#).

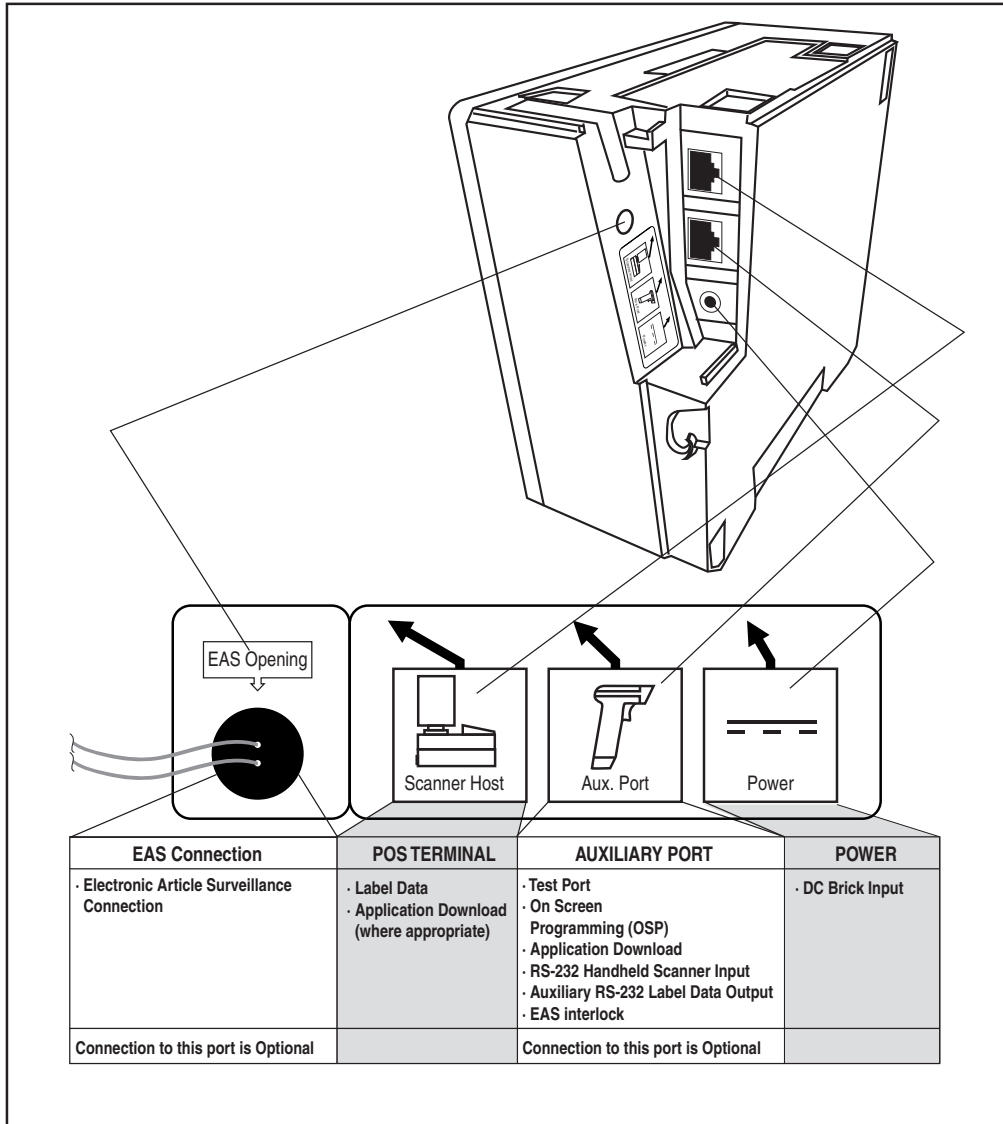
Figure 1-1. Scanner Nomenclature



Connectors

The appearance of the connector panel will vary depending upon the factory options purchased with your model. Reference [Figure 1-2](#).

Figure 1-2. Connector Panel



Physical Parameters

This section provides specifications for performance, environmental and electrical parameters. Reference the second section of this manual, *Site Preparation and Installation*, for physical measurements of all models and some accessories.

Scanning

The scanner has a scan zone immediately in front of (or above) the scan window where the scanner projects laser light in order to scan items. Scan lines form a zone where bar code labels are read. Refer to the *Operation and Maintenance* section of this manual for more details about the topic: *Scanning Items: Model 2200VS*.

AC Adapter

Figure 1-3 is an illustration of the AC/DC Adapter .

Figure 1-3. AC/DC Adapter

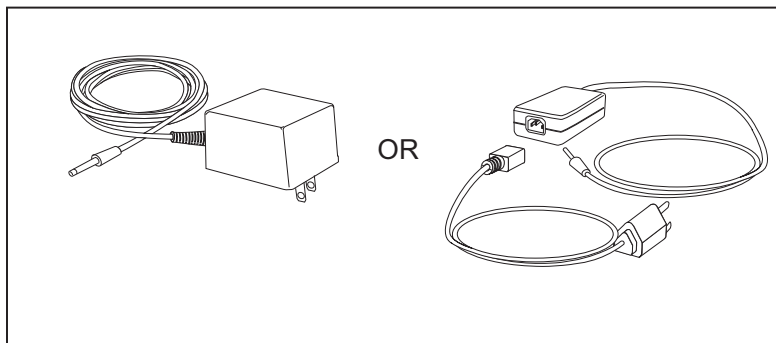
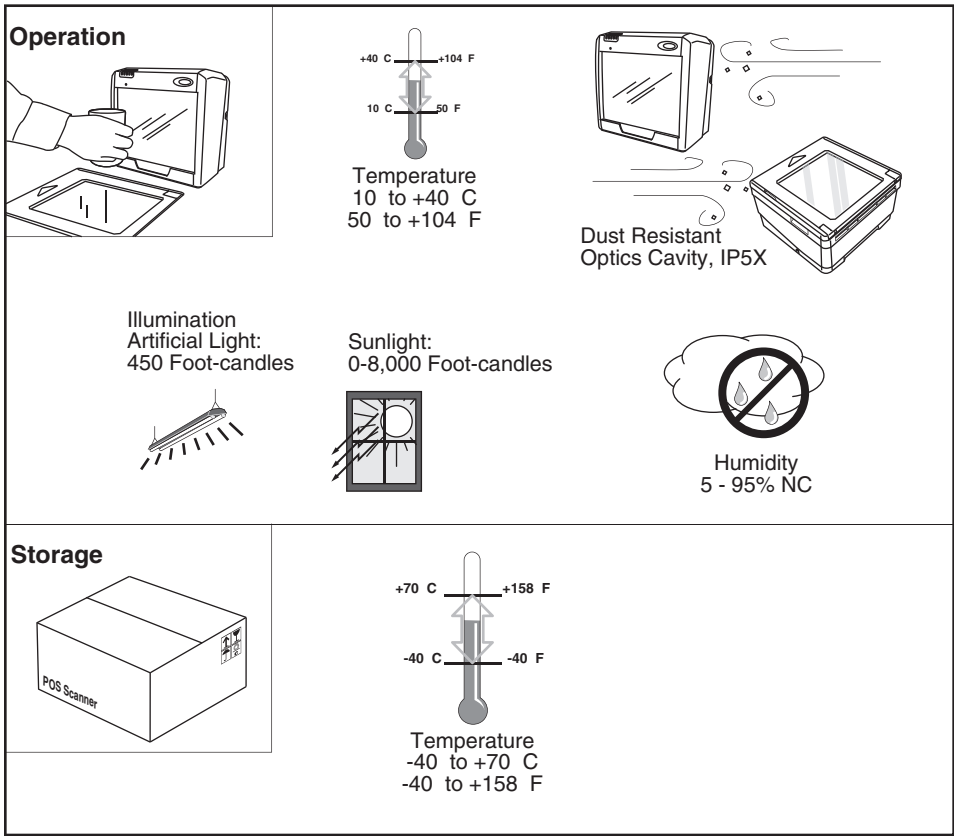


Figure 1-4. Environmental Specifications



Electrical Specifications

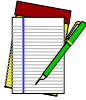
Before installation, always verify that the site’s electrical service meets the scanner’s requirements. The scanner has been engineered for compatibility with most international electrical systems. Verify that the power source will supply “clean” electrical power to the equipment; that is, it must be free of excess electrical noise.

If the adapter will not plug into your AC power receptacle, the model shipped is not compatible with your electrical system. Please contact your distributor immediately to receive the necessary information and components to ensure electrical compatibility.



CAUTION

Safe operation of your scanner or scanner requires properly grounded electrical outlets. Be sure to have a qualified electrician certify the earth-ground connection on circuits which will be used to power the unit.



NOTE

The scanner is powered on/off by connecting/disconnecting its AC power supply.

Laser and Product Safety

Laser safety requirements are based on IEC Standard Publication 60825-1 (2001) and CDRH 21CFR, Chapter 1, Subchapter J and (CDRH) Laser Product Performance Standard, User information [1040.10(h)1]:

- **User Maintenance.** No user maintenance of the system other than cleaning of the scan window(s) is required.
- **Radiant Energy.** The scanner is an IEC Class 1 and CDRH IIa laser product. The system uses two embedded Class 3R Visible Laser Diodes (VLDs) operating at 650.0 or 670.0 nm, in an opto-mechanical scanner, resulting in less than 3.9 μ W radiated power as observed through a 7mm aperture and averaged over 10 seconds. Maximum emitted peak output power at the window is 760 μ W. No attempt should be made by the user to remove the protective housing of the scanner.
- **Laser Light Viewing.** The scan window is the only aperture through which laser light may be observed in this product.

Exposure to the light emitted from the scan window(s) has been shown not to be harmful. The safety record of bar code scanning is perfect after millions of hours of use worldwide. This safe and efficient use of laser technology has gained wide acceptance in industries throughout the world.

Operators and installers of the unit should observe the following cautions and warnings:



CAUTION

Use of controls, adjustments or performance of procedures other than those specified herein may result in hazardous laser light exposure.

The use of optical instruments with the scanner will increase eye hazard. (Optical instruments include binoculars, microscopes, telescopes and magnifying glasses. This does not include eyeglasses worn by the user).

To prevent exposure to laser light, do not remove the protective housing of the scanner. There are no user-serviceable parts inside the unit.

Safety precautions to be taken:



CAUTION

No adjustments or alteration of the scanner housing are to be attempted by the user.

The failure of the facet wheel motor while the unit is continuing to emit a laser beam causes the emission levels to exceed those for inherently safe operation. The unit has safeguards to prevent this occurrence. If, however, a stationary laser beam is ever emitted, the failing unit should be disconnected from its power supply until repaired by a qualified technician.



WARNING

This equipment has been tested and found to comply with the limits for a Class A digital device, pursuant to part 15 of the FCC Rules. These limits are designed to provide reasonable protection against harmful interference when the equipment is operated in a commercial environment. This equipment generates, uses, and can radiate radio frequency energy and, if not installed and used in accordance with the instruction manual, may cause harmful interference to radio communications. Operation of this equipment in a residential area is likely to cause harmful interference in which case the user will be required to correct the interference at his or her own expense.

This Class B digital apparatus complies with Canadian ICES-0003.

Cet appareil numérique de la Classe B est conforme à la norme NMB-0003 du Canada.

Labeling

Regulatory, reference and safety labeling for both models is shown in Figure 1-5 and Figure 1-6.

Figure 1-5. Labeling: Model 2200VS

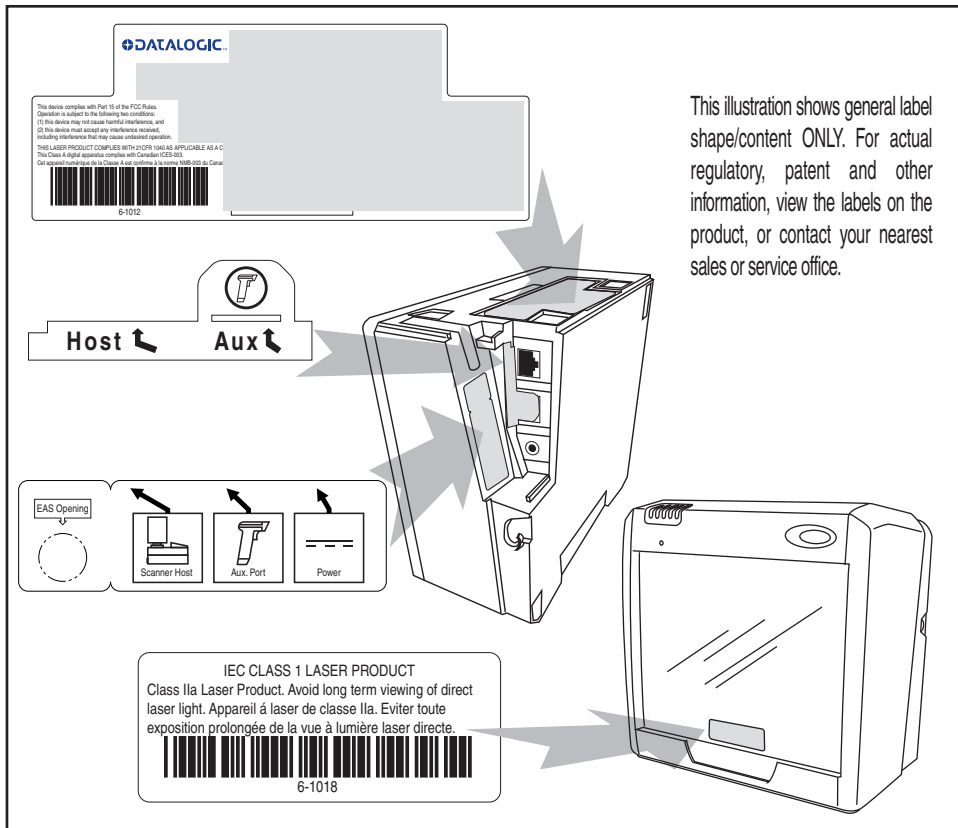
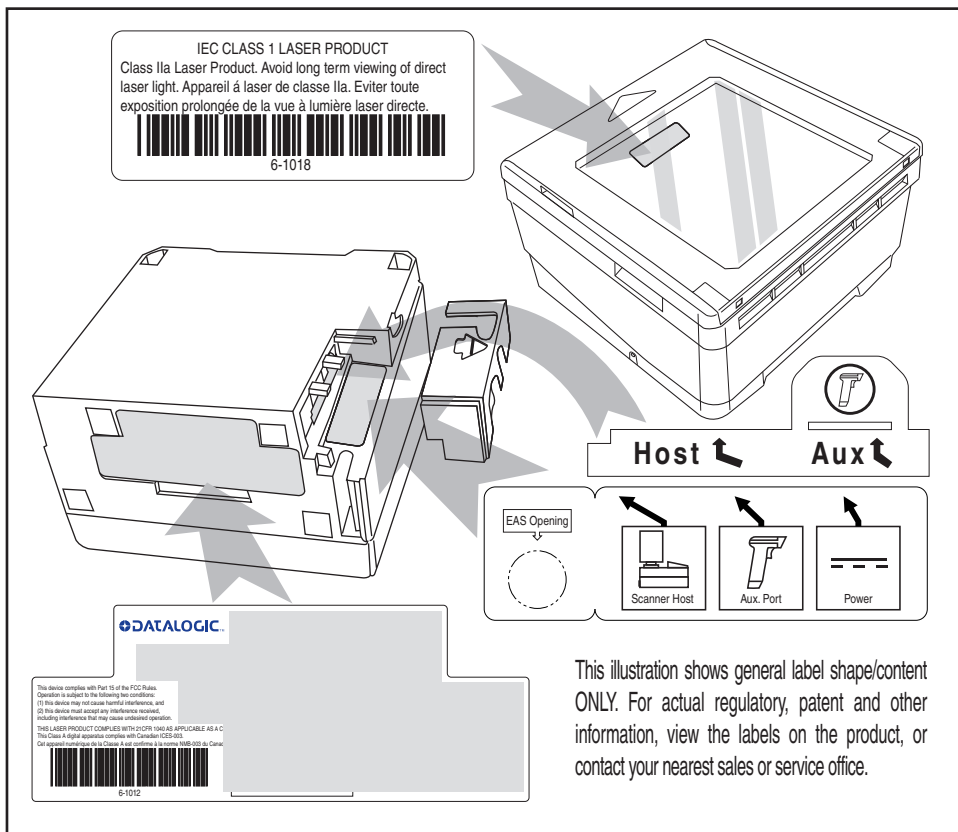


Figure 1-6. Labeling: Model 2300HS



Agency Compliances

The scanner meets or exceeds the requirements for its device type as set forth by the following agencies and regulations:

COUNTRY	COMPLIANCE	COMMENTS
Electrical		
United States	UL 1950	TÜV NRTL
Canada	CAN/CSA C22.2 No. 1950	TÜV NRTL
World	IEC60950 / IEC 825-1:2001	TÜV CB
Emmissions		
United States	47CFR Part 15J	FCC
Canada	ICES-0003	Class B
Europe	EN 55022	Class B
Australia/N Zealand	AS/NZ 3548	Class B
Japan	VCCI	Class B
Taiwan	CNS 13438	Class B
Safety & Emissions	EMC Directive 89/336/EEC	CE Mark
	LV Directive 73/23/EEC	CE Mark
Laser Safety		
United States	CDRH, 21CFR Part 1040	CDRH Class IIa laser device
Canada	same as CDRH	SGM-1 specification
Australia	AS 2211	Class 1
Europe	IEC 60825-1	Class 1

Contact Datalogic[®] Marketing or your Datalogic Scanning representative for a complete listing of approvals for other countries.

Bar Codes Supported

The scanner can read/decode the following bar code types (symbolologies):

Retail Codes

- UPC Versions A & E with full expansion E to A, plus A and E to 13 capability
- UPC Supplementals and Add-ons (Bookland & Coupon code, UPC two character supplemental encodation and UPC five character supplemental encodation and supplemental C128) with support for conditional add-ons
- DataBar Omnidirectional (formerly RSS-14)
- DataBar Expanded (formerly RSS Expanded) maximum characters 74 numeric or 41 alpha
- DataBar Stacked Omnidirectional (formerly RSS-14 Stacked)
- EAN 8 & 13 with full expansion 8 to 13
- JAN 8 & 13 with full expansion 8 to 13
- UCC/EAN 128
- Italian Pharmacode (Code 39)
- Support GTIN

Industrial Codes

- Code 39
- Code 39 full ASCII
- Code 128 (including conversion to Code 39)
- Code 93
- Interleaved 2 of 5 (I 2 of 5)
- Standard 2 of 5
- Codabar
- MSI/Plessey

Dual Bar Codes for Japan (2 label read)



The following qualifications apply to Dual Bar Codes for Japan:

NOTE

- Two label combined transmission
- Two label global midamble (see [Chapter 5, Programming](#), for more details)
- Two label flag is set by selecting any 4 digits as the flag

Chapter 2

Site Preparation and Installation

This chapter outlines the procedures for unpacking the scanner, verifying function, preparing the countertop or wall, routing cables, and installing the scanner.

Unpacking

To unpack the unit:

- Inspect the package for signs of damage that may have occurred during shipping. If damage is found, report it to your carrier immediately.
- Lift any accessories from the box, including the AC/DC Power Supply, and the Quick Reference Guide.
- Familiarize yourself with the Quick Reference Guide. Leave the guide at the checkstand when the installation is complete.
- Remove the protective packing and carefully lift the scanner from the carton. Be sure to save the box and all packing material. In the event of failure, the unit must be returned to the factory in its original packaging.

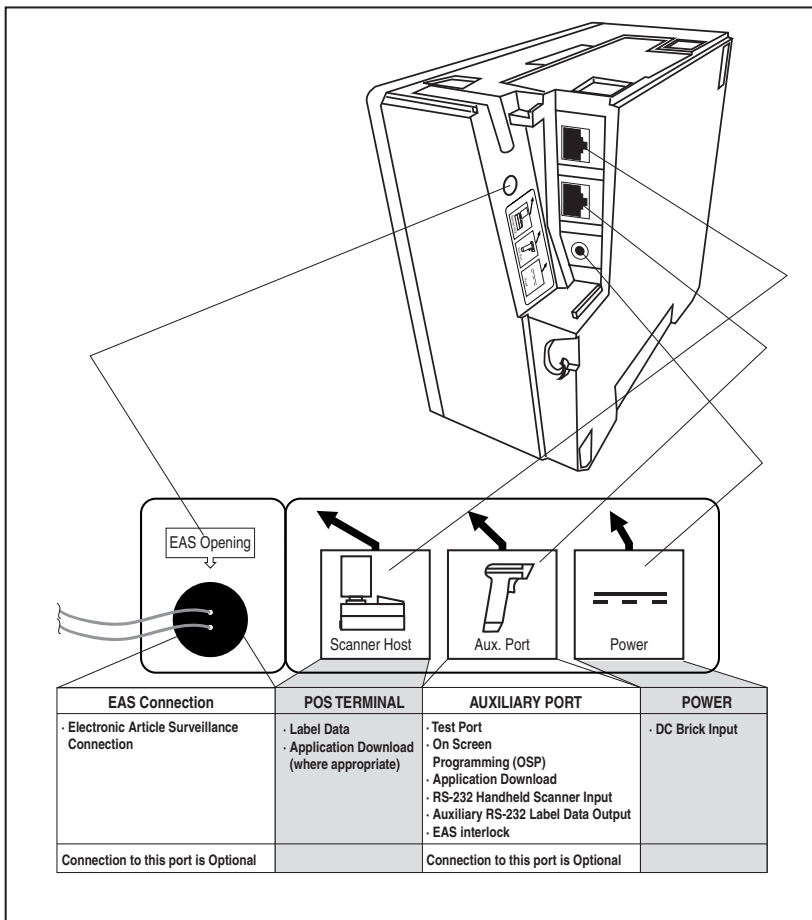
Proceed to the [Operational Verification](#) instructions below.

Operational Verification

Follow these steps to ensure that your unit has arrived undamaged and is fully functional before installing it in the counter and connecting it to your POS system:

1. [2200VS scanners ONLY] Remove the mounting bracket.
2. Plug the connector from the AC/DC Adapter into the scanner (see Figure 2-1).

Figure 2-1. Scanner Connections



3. Plug the AC Adapter into an AC power outlet.

- The scanner should beep to indicate it has passed the power-up Selftest routine, and the green LED (lamp) will light continuously, indicating the scanner is ready to scan.



Reference Chapter 4, Problem Isolation if the scanner does not perform as expected.

NOTE

- Scan a few known-good bar code labels to verify operation. Upon reading each bar code, the scanner should beep once and flash its green LED.



Your scanner may only read one or two bar codes when not connected to a host terminal, requiring that you reset the scanner before it will read again. This is normal, as some interface types require the scanner to “buffer” (store) data until the terminal signals its readiness to accept the data.

NOTE

Once you're satisfied of the scanner's operation, disconnect power and proceed to the installation instructions.

Installation: Model 2200VS

The Magellan[®] 2200VS scanner can either be used “freestanding,” or can be conveniently mounted to a countertop or wall using the mounting bracket. Provide a secure installation as described below.

- Determine the best location for scanner installation. Some considerations are:
 - Cable routing to and from the scanner: Can cables and connected devices be routed in such a way as to be protected from damage or tampering? Depending on your installation, it may be necessary to drill a 1-1/4” (3.2cm) hole in the countertop or wall.
 - Mounting stability. Avoid placing the scanner in such a way as to subject it to excess vibration, bumping, spillage, etc.
 - Peripheral connections from the scanner, such as a handheld device.

2. Determine if a cable-routing hole is necessary. If so, hold the scanner or mounting bracket in the desired, installed position to determine the center of the hole. Mark the center and drill a 1-1/4" (3.2cm) hole.
3. Secure the mount to the counter or wall using two #6 (3.5mm) pan head screws (see [Figure 2-2d](#)). If the scanner is to be used "free-standing" (not attached), remove the mounting bracket (if installed) to take advantage of the non-skid pads located on the bottom of the scanner.
4. Remove the Connector Cover and connect the cables to the scanner. Reference [Figure 2-2a](#) and [Figure 2-1](#).
5. Route the cables as shown in [Figure 2-2b](#) or [Figure 2-2c](#).
6. Switch the terminal OFF.
7. Connect the interface cable to the terminal.
8. Connect the AC Adapter to the AC outlet.
9. Switch the terminal ON.
10. Verify operation by scanning a few known-good bar code labels. The scanner should now be communicating the bar code data to the POS terminal.



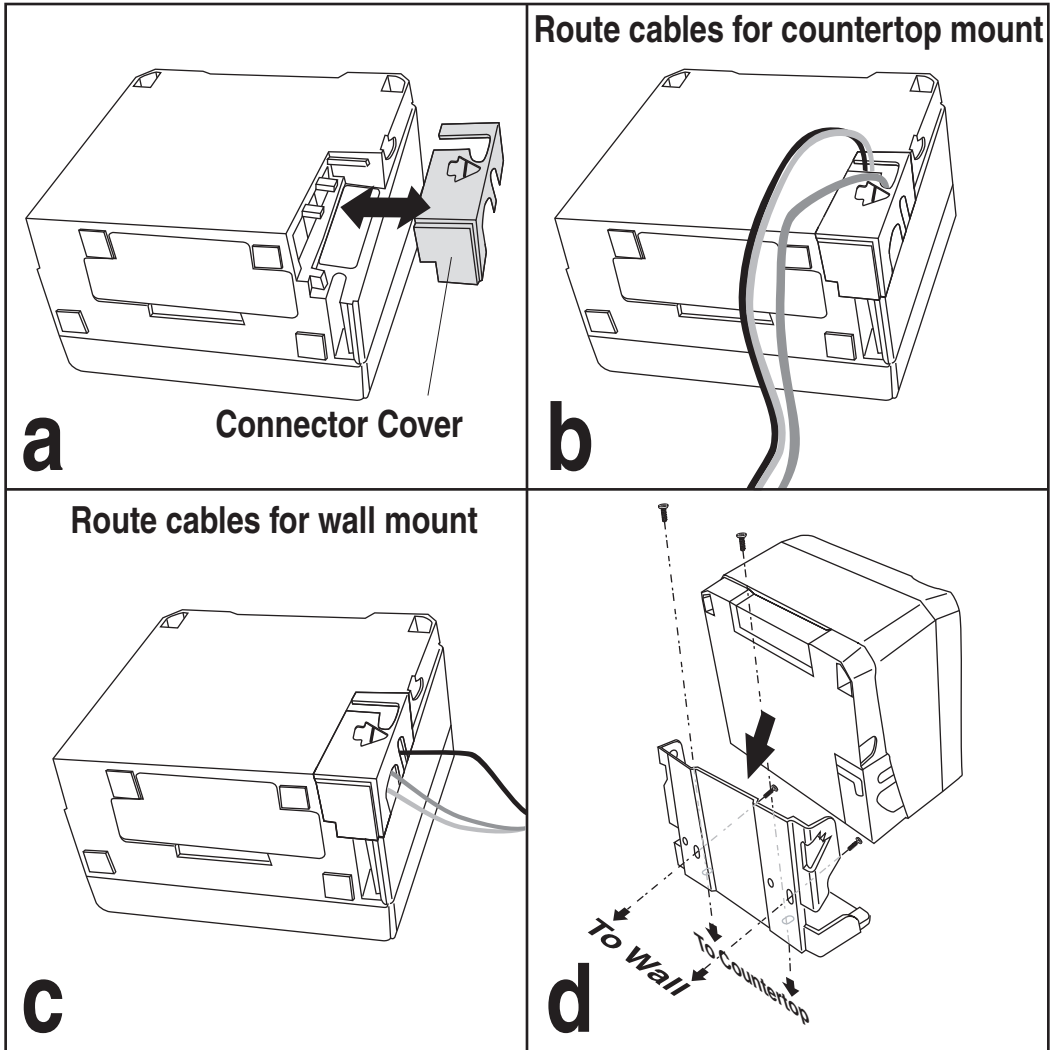
NOTE

Reference [Chapter 4, Problem Isolation](#) if the scanner does not perform as expected.

11. Slide the scanner into its mount until it's fully seated; taking care to guide cables so they won't be pinched or trapped between assemblies. Reference [Figure 2-2d](#).

This completes the installation instructions.

Figure 2-2. Magellan® 2200VS Installation



Installation: Model 2300HS

The Magellan[®] 2300HS scanner is mounted flush with the countertop to promote comfortable and ergonomic slide-through scanning. Installation as described below.

1. Determine the best location for scanner. Some considerations are:
 - Proximity to the user. Verify that checkstand features allow the unit to be within easy reach of the user, without interfering with cash drawers or other equipment.
 - Cable routing to and from the scanner: Can cables and connected devices be routed in such a way as to be protected from damage or tampering?
 - Mounting stability. Avoid placing the scanner in such a way as to subject it to excess vibration, bumping, spillage, etc.
 - Peripheral connections from the scanner, such as a handheld device.
2. The countertop must be modified to accept the scanner. At the time of this writing, three options are available.
 - [Figure 2-3a](#) shows the dimensions for the opening and other details if a shelf is to be built to support the unit.
 - [Figure 2-3b](#) details the cutout dimensions if an adapter fixture holding the scanner will rest with its rim above the countertop.
 - [Figure 2-3c](#) provides dimensions if an adapter fixture holding the scanner will be recessed to be flush with the countertop.
3. Remove the Connector Cover, then connect and route the cables at the scanner. Reference [Figure 2-4](#).
4. Seat the scanner or in the countertop opening (or adapter).
5. Switch the terminal OFF.
6. Connect the interface cable to the terminal.
7. Connect the scanner's AC Adapter to the AC outlet.
8. Switch the terminal ON.

Figure 2-3. Countertop Modification Options

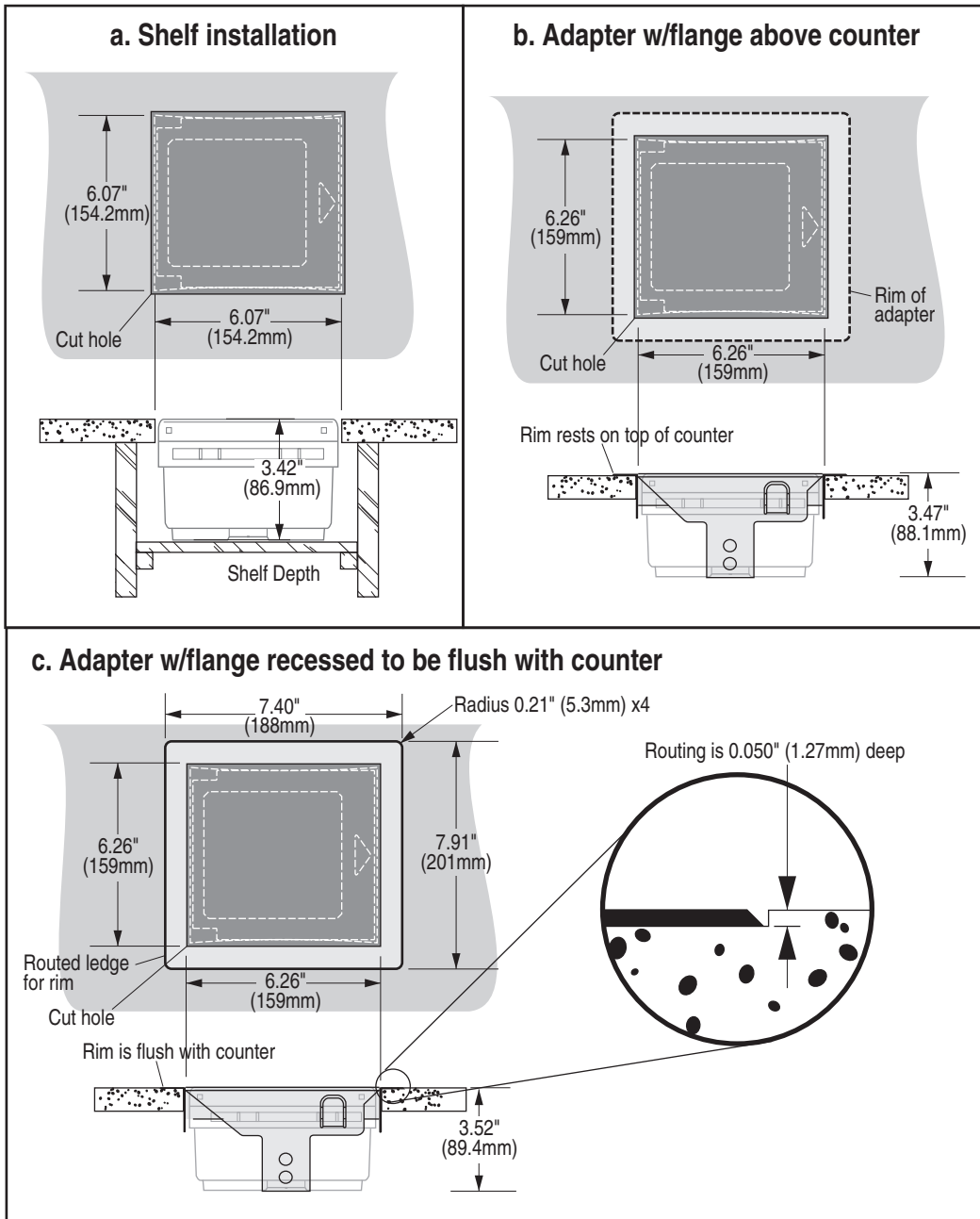
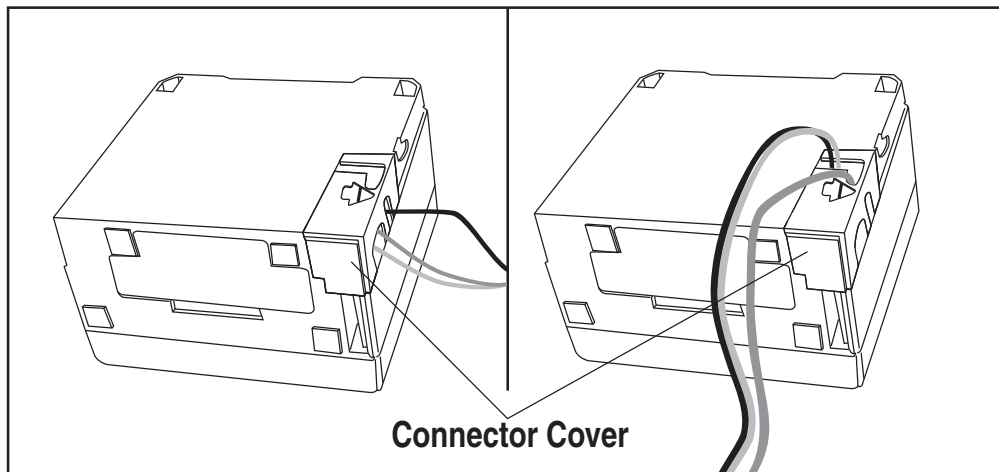


Figure 2-4. Magellan® 2300HS Cable Routing Options



9. Verify operation by scanning a few known-good bar code labels. The scanner should now be communicating the bar code data to the POS terminal.



NOTE

Reference [Chapter 4, Problem Isolation](#) if the scanner does not perform as expected.

This completes the installation instructions for this model.

Chapter 3

Operation and Maintenance

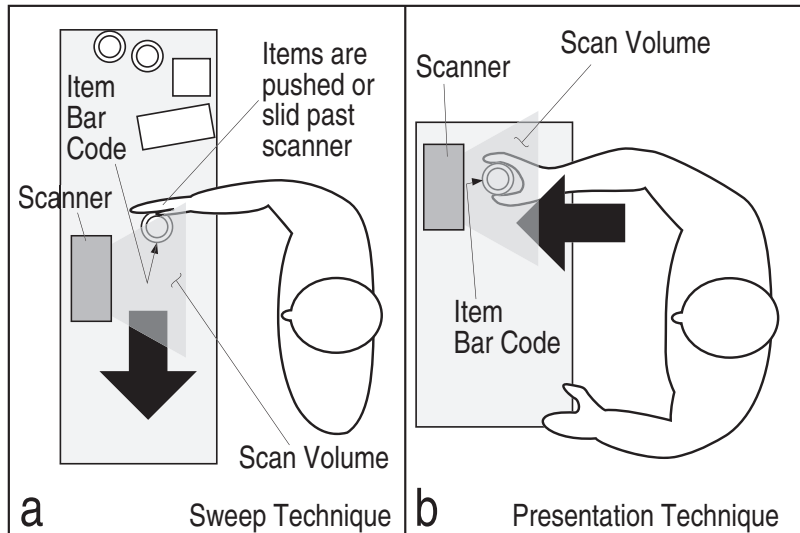
The information contained in this section describes how to operate and maintain the scanner. Topics include scanning tips, and scan window cleaning and replacement.

Scanning Items: Model 2200VS

Item bar codes are scanned by either...

- sliding or pushing items through the scan volume in a right-to-left or left-to-right motion (see **Figure 1a**). This is known as “Sweep” scanning, and is the best choice for high throughput super- and hypermarket installations where it is necessary to minimize the need to grip or lift items.
- moving the bar code directly toward the scan window to be read (see **Figure 1b**). This “Presentation” technique is most often used in low throughput variety, convenience market and pharmacy applications where usable countertop space is at a premium and “Sweep” scanning is not possible.

Figure 1. Sweep and Presentation Scanning Technique



Scanning Items: Model 2300HS

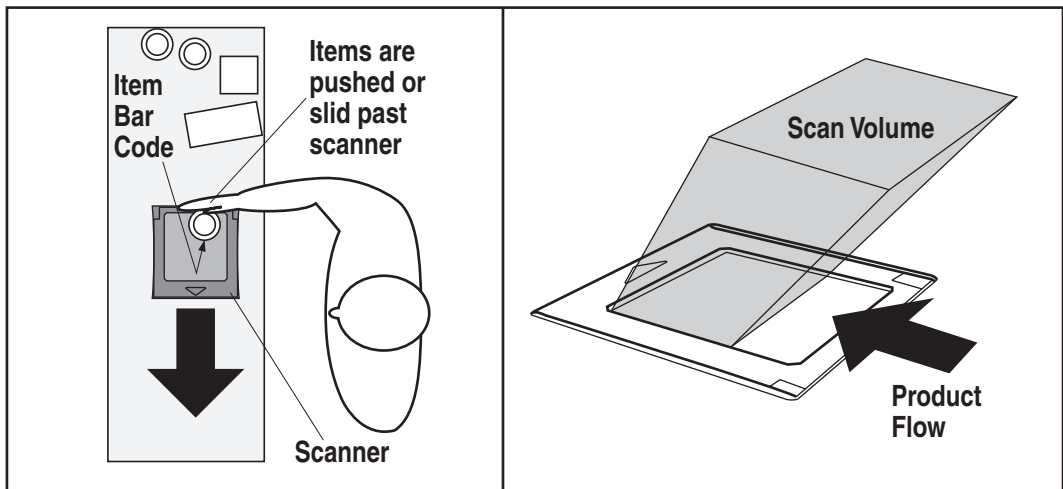
The scanner is mounted so its scan window is flush with the countertop. This allows for maximum working space, and also permits the user to slide items over its surface without having to grasp or pick them up. Bar codes are effortlessly scanned when swept through the zone projected from the substantial scan window as shown in [Figure 1a](#).



NOTE

Facing bar code labels in the direction of scanning, or toward the scan window will optimize the scan rate. The arrow on the scanner's top cover indicates the direction scanned items should be moved (see [Figure 1b](#)).

Figure 3-1. Operating the Scanner



Operational Controls

The function of scanner controls and indicators is listed in [Appendix A, LED/Beeper Indications & Controls](#). Turn to that appendix for full details.

Operational Modes

The scanner features a number of modes that are important to both the user and the system support personnel. These modes can be combined into three groups: pre-operational, operational; and additional functions. The following text describes these modes, what they mean, and how and when they are seen.

Power-Up/Selftest & Pre-Operation

Pre-Operation describes those steps that must be successfully completed before the scanner sounds the initial good read tone and illuminates the LED (lamp) indicating readiness for operation. These steps include Power-Up Selftest, Error Reporting, and Operational Configuration.

Power-Up/Selftest

Power-Up Selftest begins when power is applied. The scanner's software immediately begins the testing sequence to verify that all systems are functioning properly. This routine, which only takes a few seconds, checks all the functions of the scanner and interface prior to indicating that it is ready for operation.



NOTE

A tone indicating Selftest is complete is a configurable feature. See the topic [Power-up Beep Control](#) in Chapter 5 of this manual.

Error Reporting

If a fatal error is detected during Selftest or operation, the scanner will not advance to Normal Operation Mode. Selftest diagnostics will cause the scanner to sound a long, low tone. When this occurs, error codes may be accessed by momentarily pressing the Volume/Tone Push Button. The beeper and LED will then emit a coded series of indications to assist the repair technician in identifying the failed component. If an error is indicated, make note of the tones heard/LED flashes. A table containing a listing of the error codes is included in [Chapter 4](#).

Operational Configuration

Once Selftest diagnostics have been successfully run, a tone is emitted (if configured to do so, and the unit enters an operational configuration state. The scanner will automatically load your specific interface settings which are required to communicate with the host system.

No bar code label can be in the scan volume while the unit is in this state. Progress is halted until the label has been removed, thereby ensuring that no extraneous bar code data is sent to the host. When the scanner completes its Selftest successfully, it emits a tone (when configured to do so) and enters Operating Mode.

Operating Mode

Operating Mode includes Normal Operation (scanning) and Sleep Mode. These two modes are most commonly observed by the user/operator.

Normal Operation

This condition is indicated by the green light being on dim and steady.



NOTE

LED indications are configurable. Your scanner may not be programmed to operate in the standard manner described above.

Once the scanner enters Normal Operation, it begins a countdown sequence. If there is no activity during a preset period of time (also called time-out¹), the unit will shut off the laser and/or motor in order to prolong the life of the electrical and mechanical components. Once the scanner has timed out, it enters Sleep Mode.

Sleep Mode

After the scanner has been left idle for a preset period of time, the laser and/or motor automatically turns off (goes to sleep). This state is called Sleep Mode, and is indicated by a “slow” blink of the green light (blinking at a 2-second rate). To wake up the unit, press the Volume/Tone Push Button, wave your hand in front of the scan window, or scan an item using an attached auxiliary scanner (if present). The scanner will recognize these signals as a wake-up call and instantly return to Normal Operation.

1. “Timeout” and “Sleep Mode” time delays are programmable features that can be selected through use of the programming bar codes included in [Chapter 5](#).

Additional Functions

Additional scanner functions include programming, running scanner diagnostics, or initiating a reset.

Programming

Scanners are typically programmed at the factory to settings specified by the customer. Generally, POS system interface and bar code symbologies are pre-configured to operate in the target environment. [Chapter 5](#) contains the necessary instructions, bar codes, and descriptions to program/reprogram scanner settings.

Scanner Diagnostic Mode

While in Scanner Diagnostic Mode, continuous scanning of labels is allowed, permitting the user to scan an unlimited number of bar codes while troubleshooting problems. Under normal operation, the scanner stores label data, awaiting the signal which transmits it to the host. When the scanner is not connected to a host, it may read and store only up to two labels, then quit reading until power is cycled (clearing the memory). This mode of operation removes this limitation.

To place the scanner in Scanner Diagnostic Mode, press the Volume/Tone Push Button for approximately four seconds. While pressing the button, the scanner will first sound three tones, wait a few seconds, then sound six rapid tones; after which you should immediately release the button.

To exit Scanner Diagnostic Mode, cycle power to the scanner or press and hold the Volume/Tone Push Button for eight seconds to reset the scanner. See the topic, [Scanner Reset](#), below for more information about scanner resets.

Turn to [Chapter 4](#) for a description of error codes resulting from diagnostics.

Scanner Reset

As with any electronic equipment, it is sometimes necessary to reset the electronics. The reset procedure allows you to initiate a reset command to the scanner. This may be necessary if the POS terminal has been switched off or the store system has been reset while the unit is on. Reset can also be used to initiate and run the scanner's internal Selftest routine.

Pressing and holding the Volume/Tone Push Button for approximately eight seconds initiates a reset, which is sounded by a rapid number of beeps. If the motor had been spinning, the lamps will blink while the motor spins down. At that point, the motor will spin back up and the scanner will continue to run the Selftest diagnostics. For more information, see the topic, [Power-Up/Selftest & Pre-Operation](#), earlier in this chapter.

Operational Maintenance

The scanner will provide dependable service for many years. The following maintenance procedures will keep it operating at peak performance.

Cleaning

Clean the exterior surface of the scan window at least twice daily with a nonabrasive, mild, water-based glass cleaner and paper towels or lint-free cleaning tissues. Textured plastic surfaces and stainless steel can also be cleaned using these cleaning agents.

Chapter 4

Problem Isolation

In the event of a suspected functional problem, use the troubleshooting references provided in this section. This useful information will help you identify and resolve the cause of the problem.

The scanner incorporates features that indicate when a problem occurs. The scanner may:

- emit a series of tones
- flash the LED (lamp)

Three error reporting modes are used: Power-Up Selftest, Operational tests and Diagnostic tests. These test sequences are explained on the following pages.

Power-Up Selftest

The Power-up Selftest is a pre-operational series of tests that must be successfully completed before the scanner indicates readiness for operation. This pre-operational period is the time between power-up and normal operation during which the motor comes up-to-speed and software, firmware and hardware are being tested. These tests ensure that all subsystems are fully functional before turning on the Visible Laser Diode (VLD). Refer to [Chapter 3, Operational Modes](#), for a more detailed description of this and other scanner modes.

Operational Tests

These are the tests that run continually during Normal Operation and Sleep Mode. Firmware checks all subsystems, accessory connections as well as the POS interface to verify everything is operating normally. If a problem is detected at any time, a long, low tone is sounded and operation may be halted. If you press the Volume/Tone Push Button at that time, a series of tones will be sounded in concert with LED flashes.

Diagnostic Tests

See [Chapter 3, Scanner Diagnostic Mode](#) for details about running diagnostic tests for the scanner. If a problem is discovered during diagnostics, the scanner will provide feedback about the source of the problem. The remainder of this section describes these failure indications and includes troubleshooting flowcharts to help isolate the problem.

Diagnostic Procedures

Your Point-Of-Sale (POS) system may contain many components that operate as a system. Since almost all scanner problems are caused by either the scanner, POS terminal or communication links between them, troubleshooting flowcharts provided in this chapter focus on these components. Additionally, the AC/DC Power Supply and scanner cables are potential problems addressed.

The flowcharts provided here walk you through a diagnostic process that will isolate the failed component and instruct as to the corrective action required. Since internal scanner components cannot be replaced by an operator or installer, most functional errors will require the assistance of a trained technical support person. However, if the problem is caused by faulty cable, or power supply, you can fix the problem by replacing the defective component and complete the installation.

Error Codes

If an error is detected, the scanner will sound a long low tone (for three seconds) and flash its LED, indicating a failure. When this occurs, press the Volume/Tone Push button to hear the error code. If it is configured to do so, the scanner will sound a series of beeps corresponding to the error code and/or flash its LED simultaneous to the beeps. The table below describes what these codes mean and what action should be taken for each.



When troubleshooting, always remember to check all cable connections first before proceeding with other problem isolation steps.

Error Beep	Probable Cause	Corrective Action
Beeper “Chirp”	Configuration	No POS interface has been selected (Null interface). See Chapter 5, Interface Type to select the required interface using programming bar codes.
1	Configuration Error	See Chapter 5 for details about configuring the scanner using programming bar codes.
2	Interface Board	Unplug unit and call technical support personnel.
3	Motor	
4	Laser	
6	Digital Board	
10	Button Module	
11	Hardware ID	
14	CPLD ID	

Flowcharts

The problem isolation flowcharts on the following pages allow you to identify and troubleshoot problems with your system.

Figure 4-1. Problem Isolation: Start

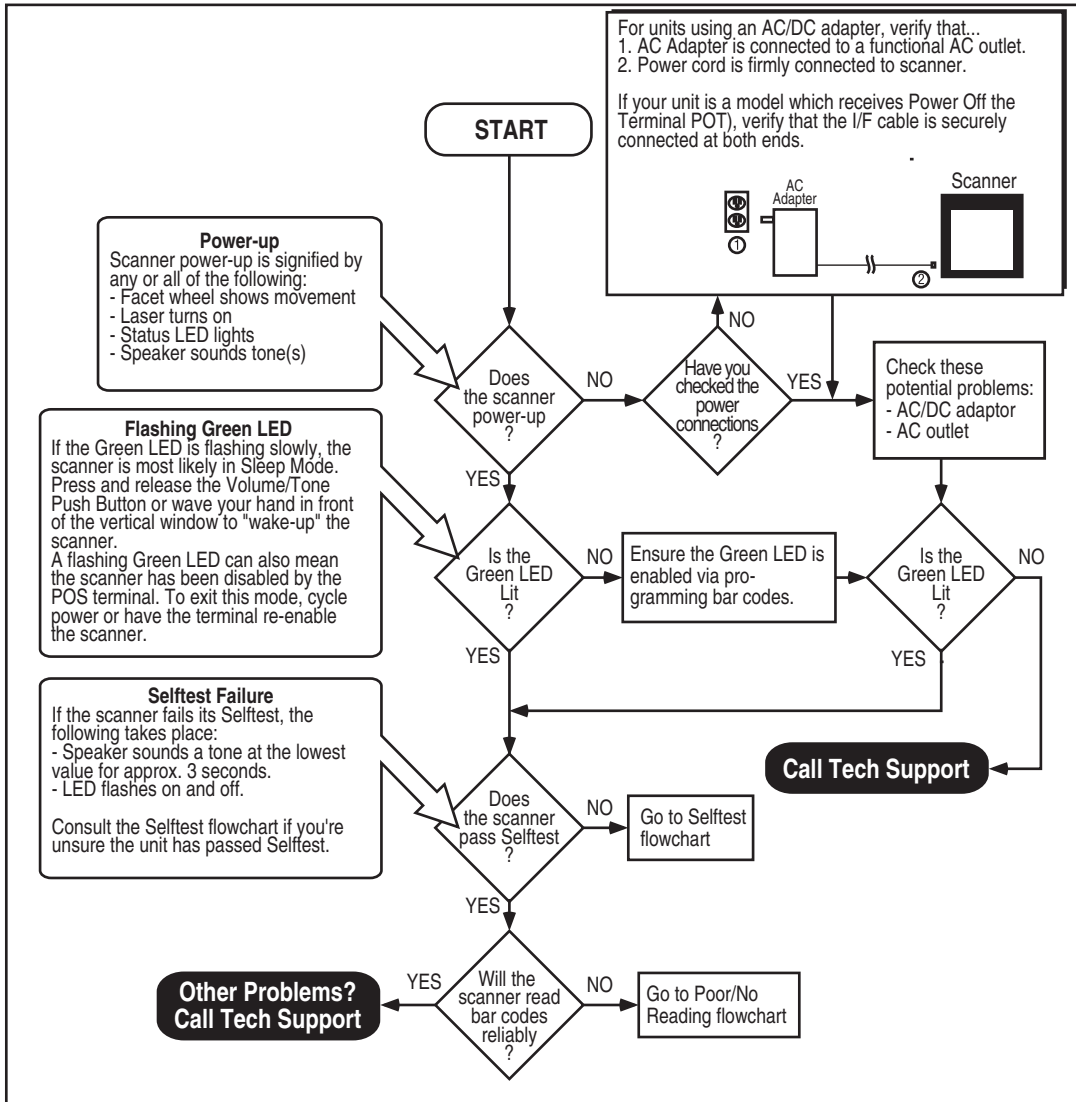


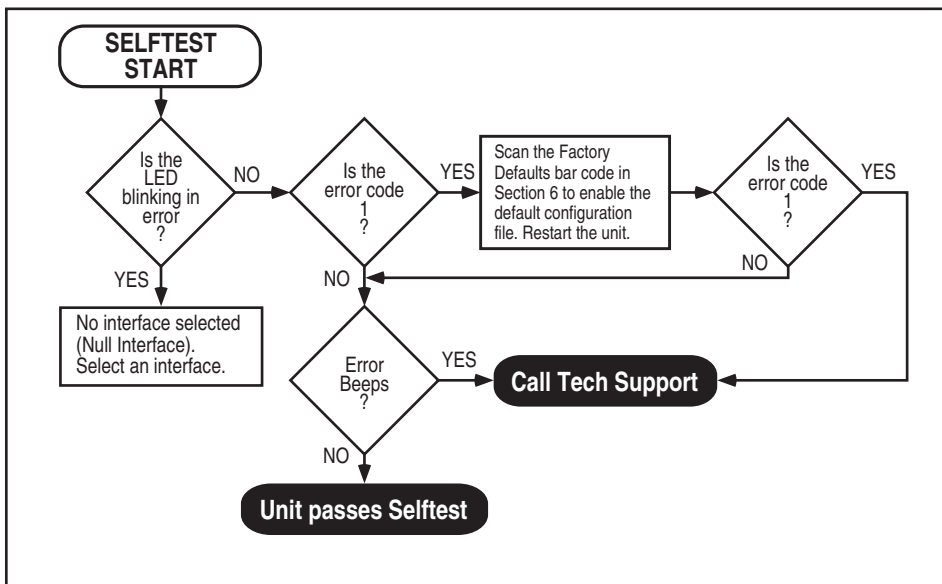
Figure 4-2. Problem Isolation: Selftest

Figure 4-3. Problem Isolation: Poor/No Reading

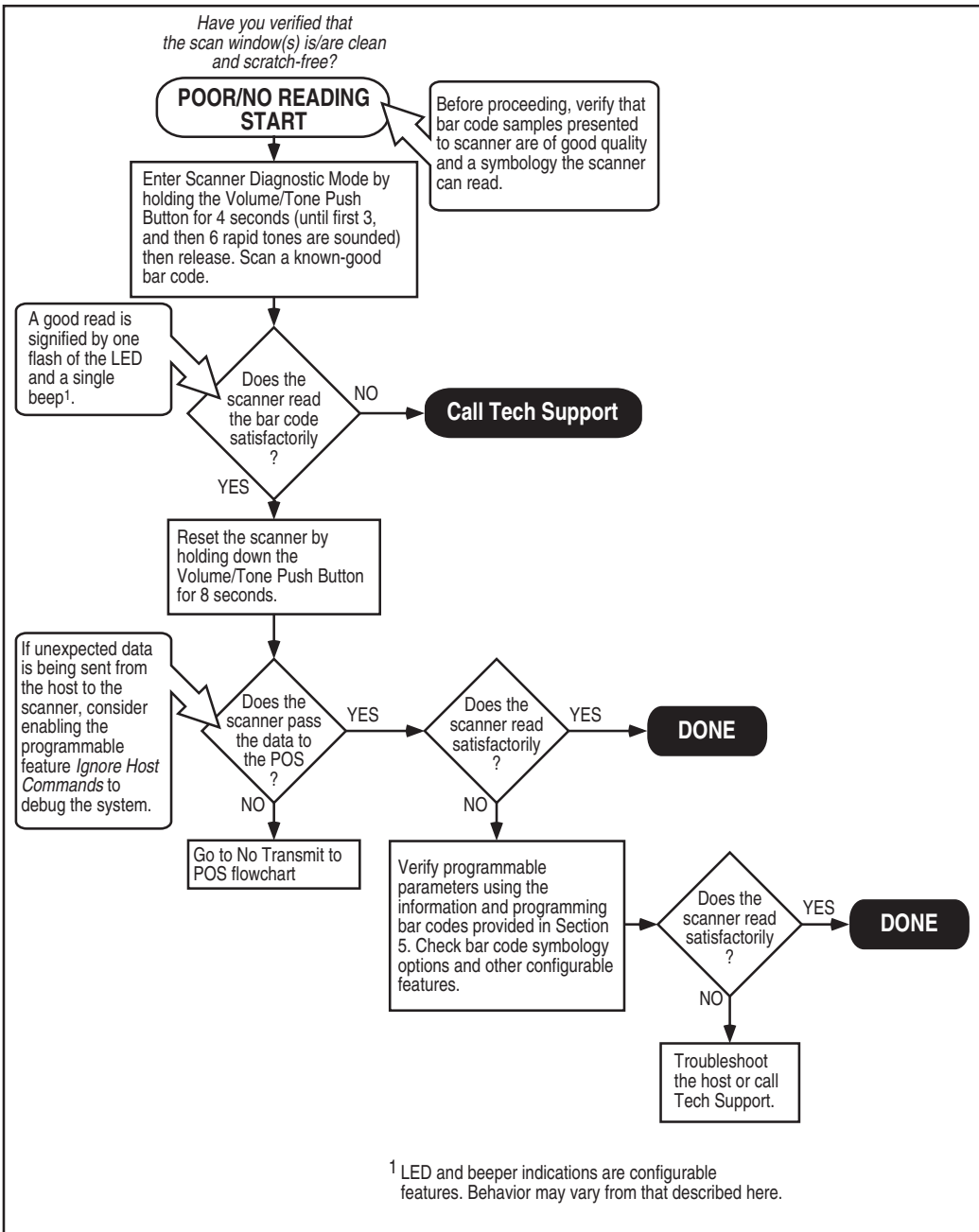
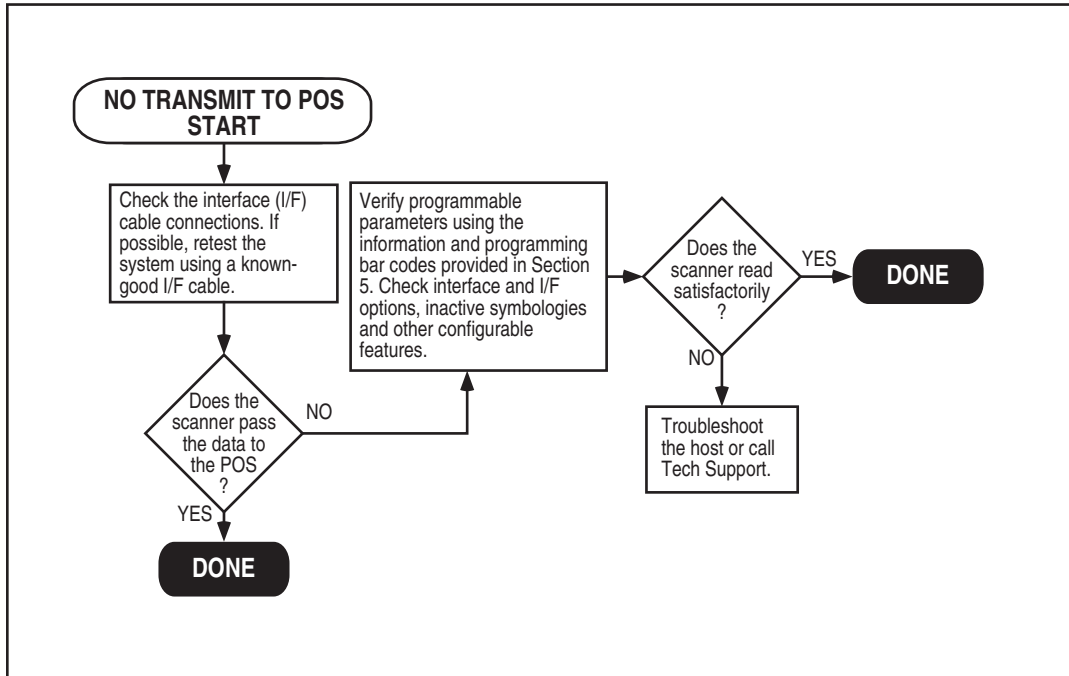


Figure 4-4. Problem Isolation: No Transmit to POS

This concludes the Problem Isolation Chapter.

NOTES

Chapter 5

Programming

Introduction to Label Programming

The programming bar code labels contained in this manual will allow you to customize and configure features and settings for your scanner . To ensure full compatibility and proper function, use only the programming bar codes in this manual and other product-specific publications to program scanner features.

This manual has been developed to make it quick and easy for users of all levels to find the information needed to understand and configure features. The following descriptions will help you to determine where to go from here.

Understanding the Basics

If you have little or no prior experience with programming using bar code labels, you should review the first few pages of this chapter to familiarize yourself with the basics of scanner programming before performing any changes to your configuration.

Integrating the Scanner With Your Host System

Your scanner **MUST** be equipped with the correct hardware (interface board, cable, etc.) to properly communicate with your host system. Contact your dealer for information if you have questions about your scanner's hardware compatibility.

You may also want to contact the dealer or your system administrator if you have no record of how your scanner was pre-programmed at the factory. Scanners are typically programmed with the default settings for specific interface types; however, your scanner may have been custom configured with settings that are unique to your company or application.

Once you know the scanner's current settings, you can determine what changes will be required to allow communication with your host system and/or optional features you choose to modify to customize your installation. After recording the modifications needed, finish reading this chapter, then turn to the appropriate page and follow the instructions to program the scanner.

When all scanner features are programmed to your satisfaction, the scanner is ready to be placed into operation.

Customizing Your Scanner's Operation

Most scanner programming falls within three general categories:

- **General Scanner Features** — are features common to all interface types. Examples include beeper adjustments such as volume and length, read verification settings, etc.
- **EAS Features** — control the settings for interfacing with the [optional] EAS device.
- **Interface Related Features** — are the mandatory settings necessary to allow communication with your host terminal. Examples of these settings are: RS-232 baud rate and parity.



CAUTION

It is possible, via programming bar codes, to change the interface type (for example: from RS-232 to IBM Port 17). Great care should be taken to select the correct interface type, since you can cause damage to the scanner and/or POS terminal by attempting to change to an incompatible interface. ALWAYS make interface selections with the host cable DISCONNECTED.

**NOTE**

Ensure that your planned modifications are compatible with the current interface. For example, baud rate selections are only valid in the RS-232 interface. The scanner will sound an error tone when scanning programming labels for features invalid to the current interface group.

- **Symbology Programming** — gives the scanner the capability to autodiscriminate as few as one, or as many as all available symbologies. For optimal scanner performance enable only those symbologies required. Additionally the scanner may be programmed with the standard options available for the various symbologies, such as check digit, minimum label length, fixed and variable length bar codes, etc.

If you experience difficulties, have questions or require additional information, contact your local distributor, or call your dealer or sales representative.

Programming Overview

The scanner's programmable feature settings can be modified to accommodate your system's unique requirements. These settings can be communicated to the scanner in one of three ways:

1. Commands can be sent directly from the host. A limited set of host commands are available. Refer to [Appendix D](#) for more details or contact Tech Support.
2. Programming bar code labels can also be used to modify the scanner's programmable settings. This manual provides the bar code labels and instructions necessary to configure the scanner's features and options.



NOTE

When you program the scanner using any of the methods above, the scanner will store the changes until reprogrammed or returned to factory defaults.

Programming via Handheld Device

The scanner can also accept programming via its auxilliary port using a handheld scanning device. Eligible handheld devices must have the ability to transmit Code 128 function codes such as the programming bar codes presented in this manual. Datalogic models QuickScan[®] 1000 and QuickScan[®] 6000 support this functionality. Handheld data format requirements (baud rate, parity, etc.) are presented in [Appendix E](#) of this manual. Additionally the programmable feature, [Auxiliary Port Mode](#), must be set to “External Handheld Input” to allow operation.

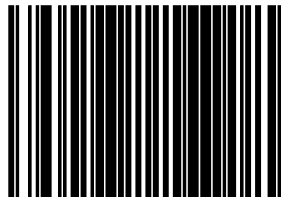
What Is Programming Mode?

Programming Mode is a state in which the scanner must be placed in order to accept commands via programming bar code labels. When programming using the bar code labels in this manual, the scanner is typically placed in Programming Mode by scanning the SWITCH label.

While in the Programming Mode, the scanner only recognizes ONLY the special programming bar codes contained in this programming guide. See [Appendix A](#) for information about scanner indications while in Programming Mode.

Entering and Exiting Programming Mode.

Use the bar code label below to enter and exit (“switch” into and out of) Programming Mode.



SWITCH LABEL

Programming Session

A typical programming session is conducted as follows:

1. Scan the SWITCH bar code to place the scanner in Programming Mode. Depending upon its current programming, the scanner may emit a beep or beeps, indicating it has read the bar code and the scanner (top) green LED will flash on and off slowly while the scanner remains in Programming Mode. Normal scanning functions are disabled.
2. Scan the programming bar code(s) that is (are) specially encoded to make the desired changes. With few exceptions¹, the scanner will emit a triple beep each time you scan a valid programming bar code.



NOTE

Not all features are available for all interfaces and the scanner will sound an error tone when scanning programming bar codes for features invalid to the current interface. Only features supported by the currently active interface will be implemented.



NOTE

If a bar code is scanned that changes the scanner's interface, all previous configuration items scanned in the programming session are lost.

Additionally, when programming a feature requiring you to scan single digits to set a multi-digit number, such as Minimum Label Length, scanning the SWITCH bar code (or any item tag/item value bar code) before completing all input will result in an error tone and cause the scanner to exit Programming Mode. Under these circumstances, the current feature you were trying to set is thrown out; any previous bar codes scanned during the session will take effect.

1. Some features, such as Minimum Label Length, require you to select the label's length by scanning a series of single-digit bar codes. A single 'good read' beep is sounded when scanning these single digits in Programming Mode. Only the final required digit in the sequence will produce a triple beep when scanned, indicating a successfully programmed feature.

**NOTE**

It is recommended that programming sessions be limited to one feature at a time. Should you make a mistake in the programming sequence, it can be difficult to discover where an error has been made if several features are programmed at once. Additionally, it can be confusing to determine which features may or may not have been successfully set following such a session.

3. Scan the SWITCH bar code to save any new settings and exit Programming Mode. The scanner will sound a beep and reset upon exiting Programming Mode, and the green LED will return to its usual state (on steady or off).

The scanner will exit Programming Mode under the following conditions:

- the programming sequence has been completed or the SWITCH bar code is scanned
 - five minutes have passed without scanning activity. Any data programmed during the current session will be ignored¹, and the scanner will reset and revert to its condition previous to initiating the exited session.
 - power is disconnected. Disconnecting power during Programming Mode, before scanning the SWITCH bar code, will cause all new settings to be ignored. On power-up, the scanner will return to previous settings.
4. Maintain a good record of all changes made to ensure that you know if the original factory settings have been changed.

1. Exception: If an interface bar code had been read while in Programming Mode, the scanner will operate on the default settings for the new interface.

Programming Sequence

To modify a scanner feature (item), the programming bar codes contained in this manual must be scanned in a given sequence depending upon the feature being programmed (as shown in [Table 5-1](#)). There are three possible programming sequences:



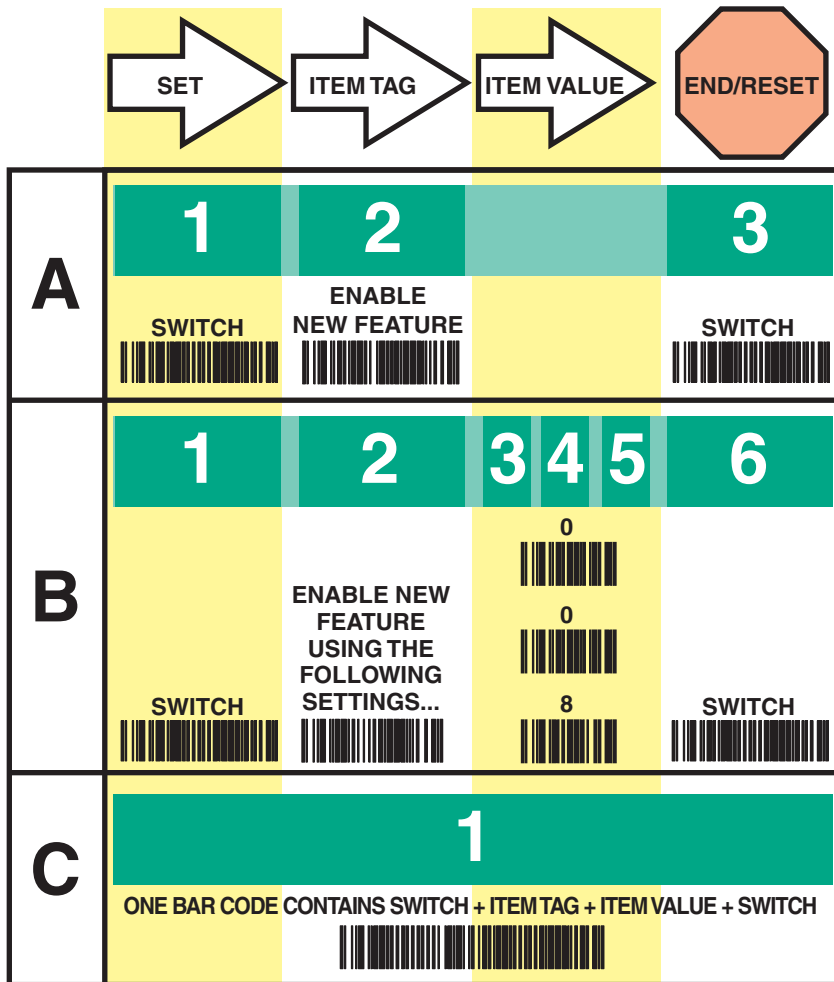
NOTE

If the scanner's interface type must be changed, always be sure that interface configuration is the FIRST item scanned during a programming session. (Selecting an interface type resets ALL other configuration items to the factory default for that interface type.)

- A. Programming sample A (the most commonly used format) demonstrates how three bar codes are scanned in sequence to do the following:
 1. Place the scanner in Programming Mode (SWITCH bar code).
 2. Scan the Item Tag¹ that will enable the new feature.
 3. End the programming session and reset the scanner (SWITCH bar code).
- B. Sample B provides an example of a programming feature requiring the entry of a range value. Like sample A, the scanner is placed in Programming Mode and an Item Tag¹ is scanned. Then, a value must be entered before ending the programming session. In the example, three digits must be scanned from the number pad in [Appendix C](#). This type of format, requiring several bar codes, is necessary to allow flexible programming for item values with larger numeric ranges.
- C. The programming sequence shown in example C requires scanning of a single, extended length bar code. This special programming bar code contains all the data necessary to enter Programming Mode, set the Item Tag¹ and Item Value, and exit Programming Mode (all in one step).

1. An "Item Tag" is a term used to describe an assigned number, which is encoded in a programming bar code, that toggles (selects, enables, disables, etc.) a specific programming feature.

Table 5-1. Programming Sequence



LED and Beeper Indicators

The scanner provides a set of indicators that verify/announce the various scanner functions.

If You Make a Mistake...

If, during a programming session, you find that you are unsure of the scanner's settings or wish to reset the scanner's configuration, use the Return to Factory Settings label below to return the scanner's configuration to the factory settings. Scanning this label will also reset any changes made during previous programming sessions.

Return to Factory Settings

Scan this bar code to return the scanner to the default settings configured at the factory for the currently active interface. This bar code is typically used to return the scanner to a "known" operating state when the present programming status is not known, faulty, or suspect.



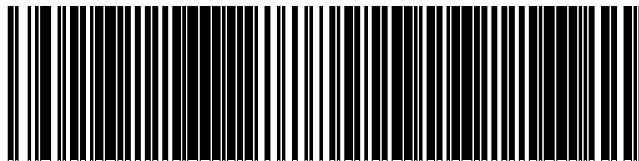
CAUTION

Use this bar code with caution, since it will reset ALL features that may have been programmed since the scanner's installation.



NOTE

DO NOT scan the SWITCH bar code before and after scanning this bar code, as the bar code below automatically enters and exits Programming Mode as a part of its function. If this bar code is scanned following a SWITCH bar code, it will simply cause the scanner to exit Programming Mode without making changes.



RETURN TO FACTORY SETTINGS

Test Mode

Use this feature to place the scanner into a testing, or “demo” mode. This special mode disables the scanner interface, meaning that bar code data is not sent out to the host via the scanner interface. This allows the bar code to be scanned continuously without requiring a response from the POS terminal.

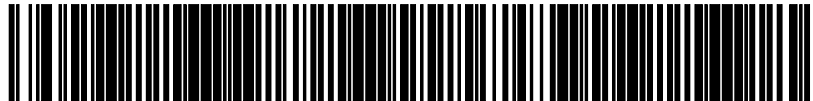
To return the scanner to normal function, scan the **TEST MODE = DISABLE** bar code below.



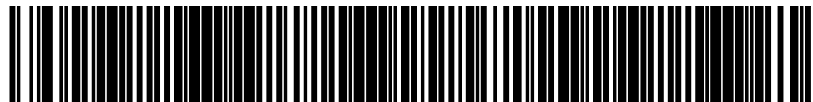
NOTE

DO NOT scan the SWITCH bar code before and after scanning the bar codes on this page.

Scanning the **TEST MODE = DISABLE bar code sets the Double Read Timeout to 600ms.**



TEST MODE = DISABLE



TEST MODE = ENABLE

General Scanner Features

Scanner Button Options

Allows configuration of the scanner (volume) button to different modes of operation.

- Disable Scanner Button — Disables all button functions
- Enable Standard Functions — Enables volume, tone, and reset.
- Enable Reset Only — The button's sole function will be to reset the scanner.

To set this feature:

1. Scan the SWITCH bar code.
2. Scan your selection from the bar codes below. You'll need to cover any unused bar codes on this and the facing page to ensure that the scanner reads only the bar code you intend to scan.
3. Complete the programming sequence by scanning the SWITCH bar code.



SCANNER BUTTON OPTIONS = DISABLE SCANNER BUTTON

Scanner Button Options — continued

Remember to cover any unused bar codes on this and the facing page to ensure that the scanner reads only the bar code you intend to scan.



SCANNER BUTTON OPTIONS = ENABLE STANDARD FUNCTIONS



SCANNER BUTTON OPTIONS = ENABLE RESET ONLY

Double Read Timeout

The Double Read Timeout feature sets a time limit that determines how much time must pass before reading the same label again (e.g. two identical items in succession).

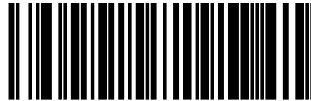
To set the Double Read Timeout:

1. Scan the SWITCH bar code.
2. Scan your selection from the bar codes below. You'll need to cover any unused bar codes on this and the facing page to ensure that the scanner reads only the bar code you intend to scan.
3. Complete the programming sequence by scanning the SWITCH bar code.



NOTE

If the incidence of multiple reads is not acceptable, increase the Double Read Timeout setting to a higher value.



DOUBLE READ TIMEOUT = 400ms



DOUBLE READ TIMEOUT = 600ms

Double Read Timeout — continued

Remember to cover any unused bar codes on this and the facing page to ensure that the scanner reads only the bar code you intend to scan.



DOUBLE READ TIMEOUT = 800ms



DOUBLE READ TIMEOUT = 1 SECOND

Laser Timeout

The laser timeout feature sets the time for switching the visible laser diodes (VLDs) off if the scanner is idle. Using this feature can prolong the life of the VLDs.

To set the Laser Timeout:

1. Scan the SWITCH bar code.
2. Scan your selection from the bar codes below. You'll need to cover any unused bar codes on this and the facing page to ensure that the scanner reads only the bar code you intend to scan.
3. Complete the programming sequence by scanning the SWITCH bar code.



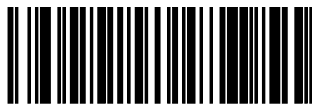
LASER TIMEOUT = 5 MINUTES

Laser Timeout — continued

Remember to cover any unused bar codes on this and the facing page to ensure that the scanner reads only the bar code you intend to scan.



LASER TIMEOUT = 10 MINUTES



LASER TIMEOUT = 15 MINUTES

Motor Timeout

The Motor Timeout feature sets the time for automatically switching the motor off when the scanner is not in use.



NOTE

Laser safety requires that the laser switch off before the motor. If you set the motor timeout shorter than the laser timeout, the motor and the laser will both shut off when the motor timeout expires.

To set the Motor Timeout:

1. Scan the SWITCH bar code.
2. Scan your selection from the bar codes below. You'll need to cover any unused bar codes on this and the facing page to ensure that the scanner reads only the bar code you intend to scan.
3. Complete the programming sequence by scanning the SWITCH bar code.



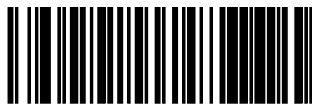
MOTOR TIMEOUT = 5 MINUTES

Motor Timeout — continued

Remember to cover any unused bar codes on this and the facing page to ensure that the scanner reads only the bar code you intend to scan.



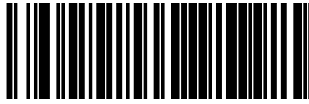
MOTOR TIMEOUT = 10 MINUTES



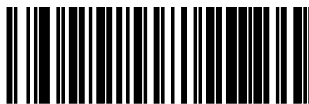
MOTOR TIMEOUT = 15 MINUTES

Motor Timeout — continued

Remember to cover any unused bar codes on this and the facing page to ensure that the scanner reads only the bar code you intend to scan.



MOTOR TIMEOUT = 30 MINUTES



MOTOR TIMEOUT = 60 MINUTES

Label Gone Timeout

Specifies the amount of time that data segments are stored by the software before being discarded if a label has not been successfully decoded during the current “label in volume session,” which is defined as the time between when the label gone time is first started until the label gone timer expires.

To set the Label Gone Timeout:

1. Scan the SWITCH bar code.
2. Scan your selection from the bar codes below. You’ll need to cover any unused bar codes on this and the facing page to ensure that the scanner reads only the bar code you intend to scan.
3. Complete the programming sequence by scanning the SWITCH bar code.



Label Gone Timeout — continued

Remember to cover any unused bar codes on this and the facing page to ensure that the scanner reads only the bar code you intend to scan.



LABEL GONE TIMEOUT = 160 mS



LABEL GONE TIMEOUT = 250 mS

Label Gone Timeout — continued

Remember to cover any unused bar codes on this and the facing page to ensure that the scanner reads only the bar code you intend to scan.



LABEL GONE TIMEOUT = 500 mS



LABEL GONE TIMEOUT = 1 Second

Auxiliary Port Mode

Selects the usage for the scanner's optional auxiliary port. The choices listed below are mutually exclusive (only one option can be active at a time).

- Disabled — Port is inactive
- External Handheld Input — Supports Datalogic® handheld scanners (QuickScan 1000, QuickScan 6000, PowerScan) as well as other models such as the Symbol® HotShot. Call your dealer for more information about supported devices.



NOTE

Cable pinout information for the Auxiliary Port is provided in [Appendix B](#) of this manual. A connected handheld scanner must be configured to transmit data as outlined in [Appendix E](#).

- PIR/CT — PIR (Productivity Index Reporting) is a value-added feature which allows the scanner to provide information to an external computer indicating how easy the label was to read. CT (Checker Training) is also a value-added feature which allows the scanner to provide feedback to the cashier on how to scan in a more ergonomic fashion

To set this feature:

1. Scan the SWITCH bar code.
2. Scan your selection from the bar codes below. You'll need to cover any unused bar codes on this and the facing page to ensure that the scanner reads only the bar code you intend to scan.
3. Complete the programming sequence by scanning the SWITCH bar code.



AUXILIARY PORT MODE = DISABLE

Auxiliary Port Mode — continued

Remember to cover any unused bar codes on this and the facing page to ensure that the scanner reads only the bar code you intend to scan.



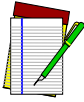
AUXILIARY PORT MODE = EXTERNAL HANDHELD INPUT



AUXILIARY PORT MODE = PIR/CT

Auxiliary Port Baud Rate

Specifies the baud rate of the auxiliary port when operating in PIR/CT mode.



PIR/CT is a value-added feature which may not have been activated on your model.

NOTE

To specify the Auxiliary Port Baud Rate:

1. Scan the SWITCH bar code.
2. Scan the desired baud rate from the bar codes below and on the immediately following pages. You'll need to cover any unused bar codes on this and the facing page to ensure that the scanner reads only the bar code you intend to scan.
3. Complete the programming sequence by scanning the SWITCH bar code.



AUXILIARY PORT BAUD RATE = 1200



AUXILIARY PORT BAUD RATE = 2400

Auxiliary Port Baud Rate — continued

Remember to cover any unused bar codes on this and the facing page to ensure that the scanner reads only the bar code you intend to scan.



RS-232 BAUD RATE = 4800



RS-232 BAUD RATE = 9600

Auxiliary Port Baud Rate — continued

Remember to cover any unused bar codes on this and the facing page to ensure that the scanner reads only the bar code you intend to scan.



RS-232 BAUD RATE = 19200



RS-232 BAUD RATE = 38400

Auxiliary Port Baud Rate — continued

Remember to cover any unused bar codes on this and the facing page to ensure that the scanner reads only the bar code you intend to scan.



RS-232 BAUD RATE = 57600



RS-232 BAUD RATE = 115200

Productivity Index Reporting (PIR)/Cashier Training (CT)

When PIR/CT is enabled, label quality data is appended to decoded data before being presented to the POS. The PIR feature allows the scanner to provide information to an external computer indicating how easy the label was to read. CT allows the scanner to provide feedback to the cashier on how to scan in a more ergonomic fashion.



NOTE

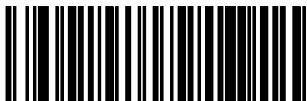
This value-added feature is a factory-programmed option. Contact your dealer for information about upgrading your system to include this advanced capability.

To set this feature:

1. Scan the SWITCH bar code.
2. Scan your selection from the bar codes below. You'll need to cover any unused bar codes on this and the facing page to ensure that the scanner reads only the bar code you intend to scan.
3. Complete the programming sequence by scanning the SWITCH bar code.



PIR/CT = DISABLE



PIR/CT = ENABLE

Indication Features

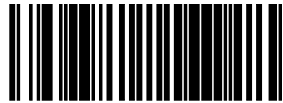
Green LED Idle State

This feature specifies the state of the green scanner LED when the scanner is idle and ready to read a label. Options are:

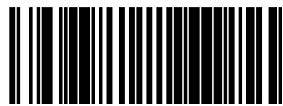
- Off
- On dim

To set the LED Idle State:

1. Scan your selection from the bar codes below. You'll need to cover any unused bar codes on this and the facing page to ensure that the scanner reads only the bar code you intend to scan.
2. Complete the programming sequence by scanning the SWITCH bar code.



GREEN LED IDLE STATE = OFF



GREEN LED IDLE STATE = ON DIM

Power-up Beep Control

Specifies the type of audible indication that is made when entering scanner-active mode on power-up. Choices are:

- No beep
- One beep
- Three beeps

To set the Power-up Beep:

1. Scan the SWITCH bar code.
2. Scan your selection from the three bar codes below. You'll need to cover any unused bar codes on this and the facing page to ensure that the scanner reads only the bar code you intend to scan.
3. Complete the programming sequence by scanning the SWITCH bar code.



Good Read Beep Control

This feature enables/disables scanner beep upon successfully decoding of a label.

To set this feature:

1. Scan the SWITCH bar code.
2. Scan your selection from the two bar codes below. You'll need to cover any unused bar codes on this and the facing page to ensure that the scanner reads only the bar code you intend to scan.
3. Complete the programming sequence by scanning the SWITCH bar code.



GOOD READ BEEP = DISABLE



GOOD READ BEEP = ENABLE

Good Read Beep Frequency

Adjusts the scanner's good read beep to sound at low, medium, or high frequency (controls the beeper's pitch/tone).

- Low = 660 Hz
- Medium = 860 Hz
- High = 1050 Hz

To set the Good Read Beep Frequency:

1. Scan the SWITCH bar code.
2. Scan your selection from the three bar codes below. You'll need to cover any unused bar codes on this and the facing page to ensure that the scanner reads only the bar code you intend to scan.
3. Complete the programming sequence by scanning the SWITCH bar code.



GOOD READ BEEP FREQUENCY = LOW

Good Read Beep Frequency — continued

Remember to cover any unused bar codes on this and the facing page to ensure that the scanner reads only the bar code you intend to scan.



GOOD READ BEEP FREQUENCY = MEDIUM



GOOD READ BEEP FREQUENCY = HIGH

Good Read Beep Length

Specifies the duration of a good read beep.

To set the good read beep length:

1. Scan the SWITCH bar code.
2. Scan the bar code, **SET GOOD READ BEEP LENGTH**. You'll need to cover any unused bar codes on this and the facing page to ensure that the scanner reads only the bar code you intend to scan.
3. Scan the appropriate digits from the keypad in **Appendix C** that represent the desired good read beep length setting. The selectable range is 1-255, which is the timeout in 10-millisecond increments. Pad all single and double digit numbers with leading zeroes to yield a three-digit entry (001-255).

Examples:

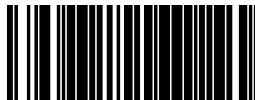
001 = 10ms

005 = 50ms

040 = 400ms

250 = 2,500ms (2.5 seconds)

4. The scanner will automatically exit Programming Mode when the appropriate amount of digits have been scanned



SET GOOD READ BEEP LENGTH

Good Read Beep Volume

Selects the beeper volume upon a good read beep. There are five selectable volumes, with each volume increment adding approximately five decibels to the previous level:

- 0 = Lowest Volume
- 1 = Medium-Low Volume
- 2 = Medium Volume
- 3 = Highest Volume

To set the Good Read Beep Volume:

1. Scan the SWITCH bar code.
2. Scan your selected volume bar code from this or the following pages. You'll need to cover any unused bar codes on this and the facing page to ensure that the scanner reads only the bar code you intend to scan.
3. Complete the programming sequence by scanning the SWITCH bar code.



GOOD READ BEEP VOLUME = LOWEST

Good Read Beep Volume — continued

Remember to cover any unused bar codes on this and the facing page to ensure that the scanner reads only the bar code you intend to scan.



GOOD READ BEEP VOLUME = MEDIUM LOW



GOOD READ BEEP VOLUME = MEDIUM

Good Read Beep Volume — continued

Remember to cover any unused bar codes on this and the facing page to ensure that the scanner reads only the bar code you intend to scan.



GOOD READ BEEP VOLUME = HIGHEST

Good Read When to Indicate

This feature specifies when the scanner will provide indication (beep and/or flash its green LED) upon successfully reading a bar code.

- Good Read = Indicate after decode
- Good Read = Indicate after transmit
- Good Read = Indicate after CTS goes inactive, then active



NOTE

The “Indicate after CTS goes inactive...” mode applies to RS-232 STD and RS-232 WN interfaces only. If set to this mode in other interfaces, “Indicate after decode” mode will be implemented.

To set the Good Read When to Indicate feature:

1. Scan the SWITCH bar code.
2. Scan the desired mode bar code from this page. You’ll need to cover any unused bar codes on this and the facing page to ensure that the scanner reads only the bar code you intend to scan.
3. Complete the programming sequence by scanning the SWITCH bar code.



GOOD READ = INDICATE AFTER DECODE

Good Read When to Indicate — continued

Remember to cover any unused bar codes on this and the facing page to ensure that the scanner reads only the bar code you intend to scan.



GOOD READ = INDICATE AFTER TRANSMIT



GOOD READ = INDICATE AFTER CTS GOES INACTIVE, THEN ACTIVE
(RS-232 ONLY)

EAS Features

EAS Active State

Specifies the active state polarity of EAS (Electronic Article Surveillance); the inactive state is its opposite polarity. EAS output goes active during the good read indication of a bar code, allowing the EAS device to deactivate a tag on the product.

To set the EAS Active State:

1. Scan the SWITCH bar code.
2. Scan your selection from the bar codes below. You'll need to cover any unused bar codes on this and the facing page to ensure that the scanner reads only the bar code you intend to scan.
3. Complete the programming sequence by scanning the SWITCH bar code.



EAS ACTIVE STATE = ACTIVE LOW



EAS ACTIVE STATE = ACTIVE HIGH

EAS Timeout

Specifies the amount of time that an EAS (Electronic Article Surveillance) signal is held in its active state for a good read indication.

To set the EAS Timeout:

1. Scan the SWITCH bar code.
2. Scan the bar code, **SET EAS TIMEOUT** below. You'll need to cover any unused bar codes on this and the facing page to ensure that the scanner reads only the bar code you intend to scan.
3. Scan the appropriate digits from the keypad in **Appendix C** that represent the desired EAS Timeout duration. The selectable range is 0-255, which is the timeout in 10-millisecond increments. Pad all single and double digit numbers with leading zeroes to yield a three-digit entry (000-255).

Examples:

000 = EAS timeout disabled

001 = 10ms

005 = 50ms

040 = 400ms

250 = 2,500ms (2.5 seconds)



NOTE

A setting of 0 (000) disables this feature.

4. Scan the SWITCH bar code to exit Programming Mode.



SET EAS TIMEOUT

Interface Related Features

Interface Type

Specifies the current scanner interface. Selections are:

INTERFACE (I/F) TYPE	I/F I.D. NUMBER
RS-232 Standard	05
RS-232 Wincor-Nixdorf	12
RS-232 Single Cable	20
USB-OEM	45
IBM Port 17	04
IBM Port 5B	08
IBM Port 9B	23
USB Keyboard	35
NOT USER-SELECTABLE	
Null Interface	

INTERFACE (I/F) TYPE	I/F I.D. NUMBER
Keyboard Wedge A	25
Keyboard Wedge B	26
Keyboard Wedge C	27
Keyboard Wedge D	28
Keyboard Wedge E	29
Keyboard Wedge F	2A
Keyboard Wedge G	31
Keyboard Wedge H	32
Keyboard Wedge I	33
Keyboard Wedge J	34

Interface Type — continued



NOTE

A new scanner may have been shipped from the factory with a Null Interface (no interface type selected) to ensure system compatibility at installation. In this case, the correct Interface Type programming bar code must be scanned first before the scanner can be used with a POS system.



NOTE

If the scanner's interface type must be changed, always be sure that interface configuration is the **FIRST** item scanned during a programming session. (Selecting an interface type resets **ALL** other configuration items to the factory default for that interface type.)

To select the desired interface:



CAUTION

Great care should be taken to select the correct interface type, since you can cause damage to the scanner and/or POS terminal by attempting to change to an incompatible interface. **ALWAYS** make interface selections with the host cable **DISCONNECTED**.



NOTE

When an interface is selected, the scanner loads the factory configuration for that interface as the selection is made, erasing any and all custom configuration that may have previously been done.

1. Disconnect current interface cable(s) if currently connected.
2. Scan the SWITCH bar code
3. Scan the bar code representing the appropriate interface located on the following pages. You'll need to cover any unused bar codes adjacent to and on any facing pages to ensure the scanner reads only the bar code you intend to scan.

Interface Type — continued

4. Complete the programming sequence by scanning the SWITCH bar code.



NOTE

Once the correct interface has been set, it will be necessary to proceed to the appropriate pages in this manual that select parameters and options for that interface. For example, if RS-232 is selected, turn to the pages in this manual headed as features specific to the RS-232 interface.

5. Connect new interface cable(s).

RS-232 Interface Selection

Remember to cover any unused bar codes on this and the facing page to ensure that the scanner reads only the bar code you intend to scan.



CAUTION

Great care should be taken to select the correct interface type, since you can cause damage to the scanner and/or POS terminal by attempting to change to an incompatible interface. ALWAYS make interface selections with the host cable DISCONNECTED.



INTERFACE TYPE = RS-232 STANDARD

RS-232 Wincor-Nixdorf Interface Selection

Remember to cover any unused bar codes on this and the facing page to ensure that the scanner reads only the bar code you intend to scan.



CAUTION

Great care should be taken to select the correct interface type, since you can cause damage to the scanner and/or POS terminal by attempting to change to an incompatible interface. **ALWAYS** make interface selections with the host cable **DISCONNECTED**.



INTERFACE TYPE = RS-232 WINCOR-NIXDORF

RS-232 Single Cable Interface Selection

Remember to cover any unused bar codes on this and the facing page to ensure that the scanner reads only the bar code you intend to scan.



CAUTION

Great care should be taken to select the correct interface type, since you can cause damage to the scanner and/or POS terminal by attempting to change to an incompatible interface. **ALWAYS** make interface selections with the host cable **DISCONNECTED**.



NOTE

Single cable installations require connection at the POS Terminal (host) port.



INTERFACE TYPE = RS-232 SINGLE CABLE

USB-OEM Interface Selection

Remember to cover any unused bar codes on this and the facing page to ensure that the scanner reads only the bar code you intend to scan.



CAUTION

Great care should be taken to select the correct interface type, since you can cause damage to the scanner and/or POS terminal by attempting to change to an incompatible interface. **ALWAYS** make interface selections with the host cable **DISCONNECTED**.



NOTE

Single cable installations require connection at the POS Terminal (host) port.



INTERFACE TYPE = USB-OEM

IBM Port 17 Interface Selection

Remember to cover any unused bar codes on this and the facing page to ensure that the scanner reads only the bar code you intend to scan.



CAUTION

Great care should be taken to select the correct interface type, since you can cause damage to the scanner and/or POS terminal by attempting to change to an incompatible interface. **ALWAYS** make interface selections with the host cable **DISCONNECTED**.



NOTE

Single cable installations require connection at the POS Terminal (host) port.



INTERFACE TYPE = IBM PORT 17

IBM Port 5B Interface Selection

Remember to cover any unused bar codes on this and the facing page to ensure that the scanner reads only the bar code you intend to scan.



CAUTION

Great care should be taken to select the correct interface type, since you can cause damage to the scanner and/or POS terminal by attempting to change to an incompatible interface. ALWAYS make interface selections with the host cable DISCONNECTED.



INTERFACE TYPE = IBM PORT 5B

IBM Port 9B Interface Selection

Remember to cover any unused bar codes on this and the facing page to ensure that the scanner reads only the bar code you intend to scan.



CAUTION

Great care should be taken to select the correct interface type, since you can cause damage to the scanner and/or POS terminal by attempting to change to an incompatible interface. ALWAYS make interface selections with the host cable DISCONNECTED.



INTERFACE TYPE = IBM PORT 9B

USB Keyboard Interface Selection

Remember to cover any unused bar codes on this and the facing page to ensure that the scanner reads only the bar code you intend to scan.



CAUTION

Great care should be taken to select the correct interface type, since you can cause damage to the scanner and/or POS terminal by attempting to change to an incompatible interface. ALWAYS make interface selections with the host cable DISCONNECTED.



INTERFACE TYPE = USB KEYBOARD

Keyboard Wedge A Interface Selection

Remember to cover any unused bar codes on this and the facing page to ensure that the scanner reads only the bar code you intend to scan.



CAUTION

Great care should be taken to select the correct interface type, since you can cause damage to the scanner and/or POS terminal by attempting to change to an incompatible interface. ALWAYS make interface selections with the host cable DISCONNECTED.



INTERFACE TYPE = KEYBOARD WEDGE A

Keyboard Wedge B Interface Selection

Remember to cover any unused bar codes on this and the facing page to ensure that the scanner reads only the bar code you intend to scan.



CAUTION

Great care should be taken to select the correct interface type, since you can cause damage to the scanner and/or POS terminal by attempting to change to an incompatible interface. ALWAYS make interface selections with the host cable DISCONNECTED.



INTERFACE TYPE = KEYBOARD WEDGE B

Keyboard Wedge C Interface Selection

Remember to cover any unused bar codes on this and the facing page to ensure that the scanner reads only the bar code you intend to scan.



CAUTION

Great care should be taken to select the correct interface type, since you can cause damage to the scanner and/or POS terminal by attempting to change to an incompatible interface. ALWAYS make interface selections with the host cable DISCONNECTED.



INTERFACE TYPE = KEYBOARD WEDGE C

Keyboard Wedge D Interface Selection

Remember to cover any unused bar codes on this and the facing page to ensure that the scanner reads only the bar code you intend to scan.



CAUTION

Great care should be taken to select the correct interface type, since you can cause damage to the scanner and/or POS terminal by attempting to change to an incompatible interface. ALWAYS make interface selections with the host cable DISCONNECTED.



INTERFACE TYPE = KEYBOARD WEDGE D

Keyboard Wedge E Interface Selection

Remember to cover any unused bar codes on this and the facing page to ensure that the scanner reads only the bar code you intend to scan.



CAUTION

Great care should be taken to select the correct interface type, since you can cause damage to the scanner and/or POS terminal by attempting to change to an incompatible interface. ALWAYS make interface selections with the host cable DISCONNECTED.



INTERFACE TYPE = KEYBOARD WEDGE E

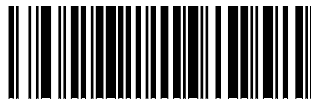
Keyboard Wedge F Interface Selection

Remember to cover any unused bar codes on this and the facing page to ensure that the scanner reads only the bar code you intend to scan.



CAUTION

Great care should be taken to select the correct interface type, since you can cause damage to the scanner and/or POS terminal by attempting to change to an incompatible interface. ALWAYS make interface selections with the host cable DISCONNECTED.



INTERFACE TYPE = KEYBOARD WEDGE F

Keyboard Wedge G Interface Selection

Remember to cover any unused bar codes on this and the facing page to ensure that the scanner reads only the bar code you intend to scan.



CAUTION

Great care should be taken to select the correct interface type, since you can cause damage to the scanner and/or POS terminal by attempting to change to an incompatible interface. ALWAYS make interface selections with the host cable DISCONNECTED.



INTERFACE TYPE = KEYBOARD WEDGE G

Keyboard Wedge H Interface Selection

Remember to cover any unused bar codes on this and the facing page to ensure that the scanner reads only the bar code you intend to scan.



CAUTION

Great care should be taken to select the correct interface type, since you can cause damage to the scanner and/or POS terminal by attempting to change to an incompatible interface. ALWAYS make interface selections with the host cable DISCONNECTED.



INTERFACE TYPE = KEYBOARD WEDGE H

Keyboard Wedge I Interface Selection

Remember to cover any unused bar codes on this and the facing page to ensure that the scanner reads only the bar code you intend to scan.



CAUTION

Great care should be taken to select the correct interface type, since you can cause damage to the scanner and/or POS terminal by attempting to change to an incompatible interface. ALWAYS make interface selections with the host cable DISCONNECTED.



INTERFACE TYPE = KEYBOARD WEDGE I

Keyboard Wedge J Interface Selection

Remember to cover any unused bar codes on this and the facing page to ensure that the scanner reads only the bar code you intend to scan.



CAUTION

Great care should be taken to select the correct interface type, since you can cause damage to the scanner and/or POS terminal by attempting to change to an incompatible interface. ALWAYS make interface selections with the host cable DISCONNECTED.



INTERFACE TYPE = KEYBOARD WEDGE J

Maximum Host-Transmitted Message Length

Specifies the maximum number of data characters allowed in messages transmitted to the host.

To set the Maximum Host-Transmitted Message Length:

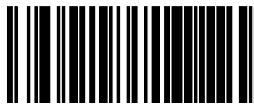
1. Scan the SWITCH bar code.
2. Scan the bar code, **SET MAXIMUM HOST-TRANSMITTED MESSAGE LENGTH** below. You'll need to cover any unused bar codes on this and the facing page to ensure that the scanner reads only the bar code you intend to scan.
3. Scan the appropriate digits from the keypad in **Appendix C** that represent the desired maximum host-transmitted message length. The selectable range is 0-249 data characters. (Labels that are longer than this length are not read.) Pad all single and double digit numbers with leading zeroes to yield a three-digit entry (000-249).



NOTE

If this configuration item is set to 0 (000), there is no general length limit imposed on data being transmitted to the host.

4. The scanner will automatically exit Programming Mode when the appropriate amount of digits have been scanned



SET MAXIMUM HOST-TRANSMITTED MESSAGE LENGTH

Number of Host Transmission Buffers

Specifies the number of host transmission(s) that may be buffered. By buffering data from a bar code, the scanner can continue to read a new bar code while the old one is being transmitted to the host. Selecting BUFFERS = 1 means that the first bar code must be transmitted before a new one can be read. A selection of BUFFERS = 2 means that a new bar code can be read while data from the first bar code is transmitted. When the feature, **Good Read Beep Control**, is enabled, the scanner will beep when the data is placed in a transmission buffer.

When a DISABLE SCANNER command is received from the host, the scanner will continue to transmit all data that is buffered.

To select the Number of Host Transmission Buffers:

1. Scan the SWITCH bar code.
2. Scan bar code below representing the desired setting. You'll need to cover any unused bar codes on this and the facing page to ensure that the scanner reads only the bar code you intend to scan.
3. Complete the programming sequence by scanning the SWITCH bar code.



NUMBER OF HOST TRANSMISSION BUFFERS = 1



NUMBER OF HOST TRANSMISSION BUFFERS = 2

AIM ID

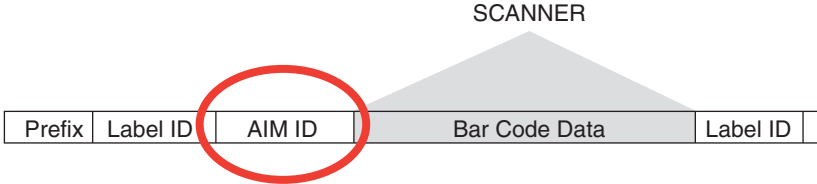
AIM label identifiers (as opposed to custom characters you select yourself as with label identifiers) can be included with scanned bar code data. AIM label identifiers consist of three characters as follows:

- A close brace character (ASCII ‘}’), followed by...
- A code character (see the table below), followed by
- A modifier character (the modifier character is symbol dependent)

SYMBOLGY	CHAR	SYMBOLGY	CHAR
UPC/EAN	E	MSI/Plessey	M
Code 39	A	PDF 417	L
Codabar	F	DataBar Omnidirectional, DataBar Expanded (RSS)	e
Interleaved.2 of 5	I	Standard 2 of 5	S
Code 93	G	ISBN	X ^a
Code 128/EAN 128	C		

a. ISBN (X with a 0 modifier character)

Figure 5-1. AIM ID



AIM ID — continued

Remember to cover any unused bar codes on this and the facing page to ensure that the scanner reads only the bar code you intend to scan.



AIM ID: DISABLE



AIM ID: ENABLE

Label ID Control

A Label ID is a customizable code of up to two ASCII characters (00-FF), used to identify a bar code (symbology) type, available for all except IBM interfaces. It can be appended previous to or following the transmitted bar code data depending upon how this option is enabled. This feature provides options for configuring custom Label IDs individually per symbology. If you wish to program the scanner to always include an industry standard label identifier for ALL symbology types, see the previous feature, [AIM ID](#).

To configure a Label ID:

1. Scan the SWITCH bar code.
2. Select Label ID position as either BEFORE or AFTER by scanning the appropriate bar code.
3. Turn to the [Symbology Programming](#) section, locate and scan the appropriate bar code to select the symbology for which you wish to configure a custom Label ID, for example: [Code 39 Label ID](#).
4. Determine the desired character(s) (you may choose either one or two) which will represent the Label ID for the selected symbology. Next, turn to the [ASCII Character Set](#) on the inside back cover of this manual and find the equivalent hex digits associated with your choice of Label ID. For example, if you wish to select an equal sign (=) as a Label ID, the chart indicates its associated hex characters as 3D.
5. Turn to [Appendix C](#) and scan the bar codes representing the hex characters determined in the previous step. For the example given, the characters '3' and 'D' would be scanned to select an equal sign (=). If a two-character Label ID is desired, for example an equal sign and the letter C (=C), scan '3', 'D', '4' and '3' to select them.
6. Scan the SWITCH bar code to exit Label ID entry.
7. Scan the SWITCH bar code once again to exit programming mode.

Figure 5-2. Label ID Position Options



Label ID Control — continued

Remember to cover any unused bar codes on this and the facing page to ensure that the scanner reads only the bar code you intend to scan.



LABEL ID TRANSMISSION: DISABLE



LABEL ID TRANSMISSION: BEFORE BAR CODE DATA

Label ID Control — continued

Remember to cover any unused bar codes on this and the facing page to ensure that the scanner reads only the bar code you intend to scan.



LABEL ID TRANSMISSION: AFTER BAR CODE DATA

Global Prefix

This feature specifies the prefix that is added to beginning of label transmission.

To specify the Global Prefix Character(s):

1. Scan the SWITCH bar code.
2. Scan the bar code, **SET GLOBAL PREFIX** below. You'll need to cover any unused bar codes to ensure the scanner reads only the bar code you intend to scan.
3. Scan the appropriate characters/digits from the keypad in **Appendix C** that represent the hex designation for the desired character(s). A table containing the **ASCII Character Set** and their corresponding Hex Values is available in the inside back cover of this manual. ASCII parameters must be input by scanning a pair of hexadecimal digits for each character. Thus, to set a two-character value of AB, bar codes containing the digits '4', '1', '4', and '2' must be scanned. The selectable range for this option is any hex value from 00 to FF. Up to 20 hex pairs can be designated.



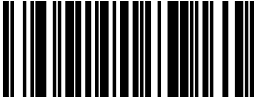
NOTE

To specify "no Global Prefix," scan 00.

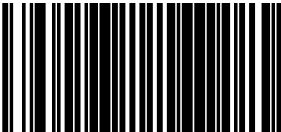
4. If designating the full 20 hex pairs, the scanner will automatically exit Programming Mode when the appropriate amount of digits have been scanned. If designating less than 20 hex pairs, you can end the programming sequence early by scanning the **TERMINATE SEQUENCE** bar code.
5. Complete the programming sequence by scanning the SWITCH bar code.

Global Prefix — continued

Remember to cover any unused bar codes on this and the facing page to ensure that the scanner reads only the bar code you intend to scan.



SET GLOBAL PREFIX



TERMINATE SEQUENCE

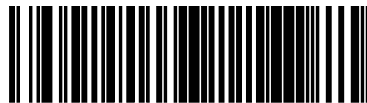
Global Suffix

This feature specifies the suffix that is added to end of a label transmission. Three standard options are available below. Contact your dealer for other alternate settings for this feature.

- No Global Suffix
- CR — Carriage Return
- CR LF — Carriage Return, Line Feed

To set the Global Suffix:

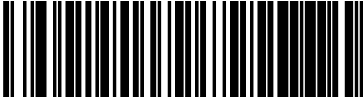
1. Scan the SWITCH bar code.
2. Scan your selection from the bar codes below.
3. Complete the programming sequence by scanning the SWITCH bar code.



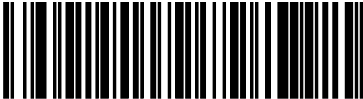
GLOBAL SUFFIX = NO GLOBAL SUFFIX

Global Suffix — continued

Remember to cover any unused bar codes on this and the facing page to ensure that the scanner reads only the bar code you intend to scan.



GLOBAL SUFFIX = CR



GLOBAL SUFFIX = CR LF

Case Conversion

Changes the case of all alphabetic characters to upper or lower case.

Choices are:

- No case conversion
- Upper case
- Lower case

To configure this feature:

1. Scan the SWITCH bar code.
2. Scan your selection from the case conversion bar codes below. You'll need to cover any unused bar codes on this and the facing page to ensure that the scanner reads only the bar code you intend to scan.
3. Complete the programming sequence by scanning the SWITCH bar code.



CASE CONVERSION = NO CASE CONVERSION

Case Conversion — continued

Remember to cover any unused bar codes on this and the facing page to ensure that the scanner reads only the bar code you intend to scan.



CASE CONVERSION = UPPER CASE

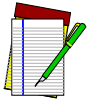


CASE CONVERSION = LOWER CASE

IBM Features

IBM Interface Options

IBM interfaces offer specific control over interaction with certain devices.



NOTE

The USB-OEM interface provides its own set of options. Refer to the feature, [USB-OEM Scanner Device Type](#), in this chapter.

Options for this feature are as follows:

- FULL host interface support — Accepts scanner configuration host commands.
- Ignore host interface configuration of scanner — Ignores all scanner configuration host commands.

To set this feature:

1. Scan the SWITCH bar code.
2. Scan your selection from the bar codes below. You'll need to cover any unused bar codes on this and the facing page to ensure that the scanner reads only the bar code you intend to scan.
3. Complete the programming sequence by scanning the SWITCH bar code.



IBM INTERFACE OPTION = FULL HOST INTERFACE SUPPORT



IBM INTERFACE OPTION = IGNORE HOST I/F CONFIG OF SCANNER

IBM Number of Host Resets

Specifies how many consecutive resets are processed before the scanner starts a five-second period during which a user is allowed to enter label-programming mode and configure the scanner.

To set the number of host resets:

1. Scan the SWITCH bar code.
2. Scan the bar code, [SET IBM NUMBER OF HOST RESETS](#). You'll need to cover any unused bar codes on this and the facing page to ensure that the scanner reads only the bar code you intend to scan.
3. Scan the appropriate digits from the keypad in [Appendix C](#) that represent the desired number of host resets. The selectable range is 1-15 resets. Pad all single and double digit numbers with leading zeroes to yield a three-digit entry (001-015).

Examples:

001 = 1 reset

005 = 5 resets

011 = 11 resets

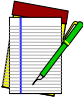
4. The scanner will automatically exit Programming Mode when the appropriate amount of digits have been scanned



SET IBM NUMBER OF HOST RESETS

IBM Transmit Labels in Code 39 Format

This feature enables/disables scanner's ability to set a symbology identifier for a specified label to Code 39 before transmitting that label data to an IBM host. This applies to: Code 128, Code 93 and Codabar for IBM Port 5B; Code 93 and Codabar for IBM Port 9B.



When enabled, this feature has no effect on IBM Port 17.

NOTE

To enable/disable the IBM Transmit Labels in Code 39 Format feature:

1. Scan the SWITCH bar code.
2. Scan either the enable or disable bar code below. You'll need to cover any unused bar codes on this and the facing page to ensure that the scanner reads only the bar code you intend to scan.
3. Complete the programming sequence by scanning the SWITCH bar code.



IBM TRANSMIT LABELS IN CODE 39 FORMAT = DISABLE



IBM TRANSMIT LABELS IN CODE 39 FORMAT = ENABLE

IBM Label Slicing Control

Enables/disables the slicing of IBM-46XX host transmission data into multiple pieces when a label is longer than the length specified by [IBM Maximum Label Slice Length](#).

Options are:

- Disable Label Slicing — Send data to host in one piece.
- Enable Label Slicing — Slice the host data into multiple pieces when necessary.

To set this feature:

1. Scan the SWITCH bar code.
2. Scan your selection from the bar codes below. You'll need to cover any unused bar codes on this and the facing page to ensure that the scanner reads only the bar code you intend to scan.
3. Complete the programming sequence by scanning the SWITCH bar code.



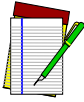
IBM LABEL SLICING CONTROL = DISABLE LABEL SLICING



IBM LABEL SLICING CONTROL = ENABLE LABEL SLICING

IBM Maximum Label Slice Length

Specifies the maximum allowable length of host transmit data in each sliced frame.



This setting only applies when **IBM Label Slicing Control** is enabled.

NOTE

1. Scan the SWITCH bar code.
2. Scan the bar code below, **SET IBM MAXIMUM LABEL SLICE LENGTH**. You'll need to cover any unused bar codes on this and the facing page to ensure that the scanner reads only the bar code you intend to scan.
3. Scan the appropriate digits from the keypad in **Appendix C** that represent the desired slice length. The selectable range is a length from 14 to 246. Pad all single and double digit numbers with leading zeroes to yield a three-digit entry (014-100).
4. The scanner will automatically exit Programming Mode when the appropriate amount of digits have been scanned.



SET IBM MAXIMUM LABEL SLICE LENGTH

USB-OEM Scanner Device Type

The IBM-USB protocol allows for the scanner to be identified as one of two different types of barcode scanners. Depending on what other scanners you may already have connected to a USB POS, you may need to change this setting to enable all scanners to communicate. Options are:

- Table Top Scanner
- Handheld Scanner

To set this feature:

1. Scan the SWITCH bar code.
2. Scan your selection from the bar codes below. You'll need to cover any unused bar codes on this and the facing page to ensure that the scanner reads only the bar code you intend to scan.
3. Complete the programming sequence by scanning the SWITCH bar code.



USB-OEM SCANNER DEVICE TYPE = TABLE TOP SCANNER



USB-OEM SCANNER DEVICE TYPE = HANDHELD SCANNER

RS-232 Features

RS-232 Baud Rate

This feature selects the baud rate required for sending and receiving data.



NOTE

Single cable interfaces are limited to Baud Rate selections up to 19200. They cannot communicate at Baud Rates of 38400 and up.

To specify the RS-232 Baud Rate:

1. Scan the SWITCH bar code.
2. Scan the desired baud rate from the bar codes below and on the immediately following pages. You'll need to cover any unused bar codes on this and the facing page to ensure that the scanner reads only the bar code you intend to scan.
3. Complete the programming sequence by scanning the SWITCH bar code.



RS-232 BAUD RATE = 1200



RS-232 BAUD RATE = 2400

RS-232 Baud Rate — continued

Remember to cover any unused bar codes on this and the facing page to ensure that the scanner reads only the bar code you intend to scan.



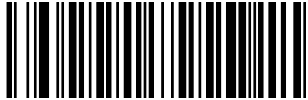
RS-232 BAUD RATE = 4800



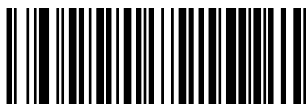
RS-232 BAUD RATE = 9600

RS-232 Baud Rate — continued

Remember to cover any unused bar codes on this and the facing page to ensure that the scanner reads only the bar code you intend to scan.



RS-232 BAUD RATE = 19200



RS-232 BAUD RATE = 38400

RS-232 Baud Rate — continued

Remember to cover any unused bar codes on this and the facing page to ensure that the scanner reads only the bar code you intend to scan.



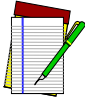
RS-232 BAUD RATE = 57600



RS-232 BAUD RATE = 115200

RS-232 Number of Data Bits

Specifies number of data bits required for sending and receiving data.



NOTE

8 data bits with 2 stop bits and parity enabled is not a valid configuration.

To set this feature:

1. Scan the SWITCH bar code.
2. Scan the bar code below representing the desired Data Bit setting. You'll need to cover any unused bar codes on this and the facing page to ensure that the scanner reads only the bar code you intend to scan.
3. Complete the programming sequence by scanning the SWITCH bar code.



RS-232 NUMBER OF DATA BITS = 7



RS-232 NUMBER OF DATA BITS = 8

RS-232 Number of Stop Bits

Specifies number of stop bits required for sending and receiving data.



NOTE

8 data bits with 2 stop bits and parity enabled is not a valid configuration.

To set this feature:

1. Scan the SWITCH bar code.
2. Scan the bar code below representing the desired Stop Bit setting. You'll need to cover any unused bar codes on this and the facing page to ensure that the scanner reads only the bar code you intend to scan.
3. Complete the programming sequence by scanning the SWITCH bar code.



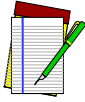
RS-232 NUMBER OF STOP BITS = 1



RS-232 NUMBER OF STOP BITS = 2

RS-232 Parity

Specifies parity required for sending and receiving data.



NOTE

8 data bits with 2 stop bits and parity enabled is not a valid configuration.

Options for this setting are:

- RS-232 PARITY = NONE
- RS-232 PARITY = EVEN
- RS-232 PARITY = ODD

To set this feature:

1. Scan the SWITCH bar code.
2. Scan the bar code below or on the following pages representing the desired Parity setting. You'll need to cover any unused bar codes, as well as facing pages to ensure that the scanner reads only the bar code you intend to scan.
3. Complete the programming sequence by scanning the SWITCH bar code.



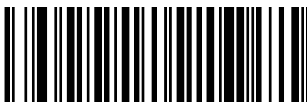
RS-232 PARITY = NONE

RS-232 Parity — continued

Remember to cover any unused bar codes on this and the facing page to ensure that the scanner reads only the bar code you intend to scan.



RS-232 PARITY = EVEN



RS-232 PARITY = ODD

RS-232 Hardware Control

Enables/disables use of the RS-232 CTS signal for flow control and/or scan control.

Options are:

- **Disable** — The scanner transmits to the host regardless of any activity on the CTS line.
- **Enable CTS Flow Control** — The CTS signal controls transmission of data to the host.
- **Enable CTS Scan Control** — The CTS line must be active for scanner to read and transmit data. While the CTS line is inactive, scanner remains in a host- disabled state; following a successful label transmission, the CTS signal must transition to inactive and then to active to enable scanning for the next label.
- **Enable Magellan SL CTS scan control** — Emulates default Magellan SL setting for this feature.

To set this feature:

1. Scan the SWITCH bar code.
2. Scan bar code below or from the following page for the desired setting. You'll need to cover any unused bar codes on facing pages to ensure that the scanner reads only the bar code you intend to scan.
3. Complete the programming sequence by scanning the SWITCH bar code.



RS-232 HARDWARE CONTROL = DISABLE

RS-232 Hardware Control — continued

Remember to cover any unused bar codes on this and the facing page to ensure that the scanner reads only the bar code you intend to scan.



RS-232 HARDWARE CONTROL = ENABLE CTS FLOW CONTROL



RS-232 HARDWARE CONTROL = ENABLE CTS SCAN CONTROL

RS-232 Hardware Control — continued

Remember to cover any unused bar codes on this and the facing page to ensure that the scanner reads only the bar code you intend to scan.



RS-232 HARDWARE CONTROL = ENABLE MGL SL CTS SCAN CONTROL

RS-232 Intercharacter Delay

Specifies delay between the end of one character and the beginning of the next in 10-millisecond increments.

To set the RS-232 Intercharacter Delay:

1. Scan the SWITCH bar code.
2. Scan the bar code below, **SET RS-232 INTERCHARACTER DELAY**. You'll need to cover any unused bar codes on this and the facing page to ensure that the scanner reads only the bar code you intend to scan.
3. Scan the appropriate digits from the keypad in **Appendix C** that represent the desired delay. The selectable range is 0-100, which is the delay in 10-millisecond increments. Pad all single and double digit numbers with leading zeroes to yield a three-digit entry (000-100).
Examples:
001 = 10ms
005 = 50ms
040 = 400ms
100 = 1,000ms (1 second)
4. The scanner will automatically exit Programming Mode when the appropriate amount of digits have been scanned.



SET RS-232 INTERCHARACTER DELAY

RS-232 Software Flow Control

Enables/disables RS-232 Flow Control using XON/ XOFF characters. .



This item will be ignored when the feature, [RS-232 NAK Character](#), is enabled

NOTE

To set this feature:

1. Scan the SWITCH bar code.
2. Scan either the enable or disable bar code below. You'll need to cover any unused bar codes on this and the facing page to ensure that the scanner reads only the bar code you intend to scan.
3. Complete the programming sequence by scanning the SWITCH bar code.



RS-232 SOFTWARE FLOW CONTROL = DISABLE



RS-232 SOFTWARE FLOW CONTROL = ENABLE

RS-232 Host Echo

When enabled, this feature passes all data through the scanner to the host as it comes in. This feature is used for applications where “daisy chaining” of RS-232 devices onto the same cable is necessary. If, for example, one of the devices in the chain is a terminal where someone is entering data while another person is simultaneously scanning a bar code requiring transmission to the host, the scanner will wait for the RS-232 channel to be quiet for a specified period of time (set via [RS-232 Host Echo Quiet Interval](#)). The scanner can be set to observe this delay before sending its data in order to avoid RS-232 transmission conflicts.



NOTE

When RS-232 Host Echo is enabled, the following features are ignored: RS-232 Software Flow Control and RS-232 ACK NAK Enable as well as all other ACK/ NAK related operations, plus processing of RS-232 host commands.

To enable/disable this feature:

1. Scan the SWITCH bar code.
2. Scan either the enable or disable bar code below. You'll need to cover any unused bar codes on this and the facing page to ensure that the scanner reads only the bar code you intend to scan.
3. Complete the programming sequence by scanning the SWITCH bar code.



RS-232 Host Echo Quiet Interval

This setting specifies the time interval of RS-232 channel inactivity which must transpire before the scanner will break the host echo loop to transmit the bar code data that has just been scanned to the host.

- 0 - 100 = Time in 10-millisecond increments.

To set the Host Echo Quiet Interval:

1. Scan the SWITCH bar code.
2. Scan the bar code below, **SET RS-232 HOST ECHO QUIET INTERVAL**. You'll need to cover any unused bar codes on this and the facing page to ensure that the scanner reads only the bar code you intend to scan.
3. Scan the appropriate digits from the keypad in **Appendix C** that represent the desired timeout. The selectable range is 0-100, which is the timeout in 10-millisecond increments. Pad all single and double digit numbers with leading zeroes to yield a three-digit entry (000-100).

Examples:

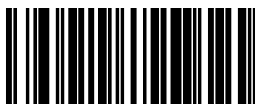
001 = 10ms

005 = 50ms

040 = 400ms

100 = 1,000ms (1 second)

4. The scanner will automatically exit Programming Mode when the appropriate amount of digits have been scanned.



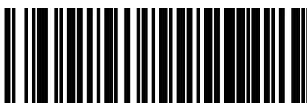
SET RS-232 HOST ECHO QUIET INTERVAL

RS-232 Ignore Host Commands

When set to ignore host commands, the scanner will ignore all host commands except for the minimum set necessary to keep the interface active, and transmit labels. For normal operation of the interface, disable this feature.

To set this feature:

1. Scan the SWITCH bar code.
2. Scan your selection from the bar codes below. You'll need to cover any unused bar codes on this and the facing page to ensure that the scanner reads only the bar code you intend to scan.
3. Complete the programming sequence by scanning the SWITCH bar code.



RS-232 IGNORE HOST COMMANDS =
NORMAL (DO NOT IGNORE HOST COMMANDS)



RS-232 IGNORE HOST COMMANDS = ENABLE

RS-232 TTL

Specifies whether RS-232 interface provides TTL levels on the output pins TxD and RTS.

Choices are:

- Normal RS-232 levels
- TTL levels

To set this feature:

1. Scan the SWITCH bar code.
2. Scan the bar code below which represents the desired setting for this feature. You'll need to cover any unused bar codes on this and the facing page to ensure that the scanner reads only the bar code you intend to scan.
3. Complete the programming sequence by scanning the SWITCH bar code.



RS-232 LEVELS = NORMAL RS-232



RS-232 LEVELS = TTL

RS-232 TTL Invert

Enables/disables inversion of TTL.

To set this feature:

1. Scan the SWITCH bar code.
2. Scan the bar code below which represents the desired setting for this feature. You'll need to cover any unused bar codes on this and the facing page to ensure that the scanner reads only the bar code you intend to scan.
3. Complete the programming sequence by scanning the SWITCH bar code.



RS-232 ICL DC1 Character Delay Enable

Enables/disables the ability of the scanner to delay a DC1 response for 40 milliseconds.

To set this feature:

1. Scan the SWITCH bar code.
2. Scan the bar code below which represents the desired setting for this feature. You'll need to cover any unused bar codes on this and the facing page to ensure that the scanner reads only the bar code you intend to scan.
3. Complete the programming sequence by scanning the SWITCH bar code.



RS-232 ICL DC1 CHARACTER DELAY = DISABLE



RS-232 ICL DC1 CHARACTER DELAY = ENABLE

RS-232 Beep on ASCII BEL

Enables/disables ability of scanner to beep (sound a good read tone) on receiving an ASCII BEL (07 hex).

- Disable
- Enable

To enable/disable this feature:

1. Scan the SWITCH bar code.
2. Scan either the enable or disable bar code below. You'll need to cover any unused bar codes on this and the facing page to ensure that the scanner reads only the bar code you intend to scan.
3. Complete the programming sequence by scanning the SWITCH bar code.



RS-232 BEEP ON ASCII BEL = DISABLE



RS-232 BEEP ON ASCII BEL = ENABLE

RS-232 Beep on Not on File

Select for the host to beep (or not) when a not-on-file condition is detected by the host. This feature is also applicable to single cable RS-232.



RS-232 BEEP ON NOT ON FILE = DISABLE



RS-232 BEEP ON NOT ON FILE = ENABLE

RS-232 ACK NAK Enable

This enables/disables the ability of the scanner to support the RS-232 ACK/NAK protocol. When configured, the scanner and/or host sends an “ACK” when it receives data properly, and sends “NAK” when the data is in error. Selections for this option are:

- Disable
- Label Transmission — the scanner expects an ACK/NAK response from the host when a label is sent)
- Host Acknowledgement — Enabled for Host Commands (the scanner will respond with ACK/NAK when the host sends a command)
- Label & Host — Enabled for both Label Transmission & Host Commands

To select the option for RS-232 ACK NAK Enable:

1. Scan the SWITCH bar code.
2. Scan the desired option from bar codes below and on the following page. You’ll need to cover any unused bar codes on this and the facing page to ensure that the scanner reads only the bar code you intend to scan.
3. Complete the programming sequence by scanning the SWITCH bar code.



RS-232 ACK NAK Enable — continued

Remember to cover any unused bar codes on this and the facing page to ensure that the scanner reads only the bar code you intend to scan.



RS-232 ACK/NAK = HOST ACKNOWLEDGEMENT



RS-232 ACK/NAK = LABEL & HOST

RS-232 ACK Character

This feature specifies which ASCII character will be used as an ACK character.



NOTE

DO NOT set this feature to use previously defined characters such as XON, XOFF or host commands as this will conflict with normal operation of these characters. 8-bit data is not recognized when the feature, RS-232 Number of Data Bits, is set to 7 data bits.

To specify the RS-232 ACK Character:

1. Scan the SWITCH bar code.
2. Scan the bar code, [SET RS-232 ACK CHARACTER](#) below. You'll need to cover any unused bar codes on this and the facing page to ensure the scanner reads only the bar code you intend to scan.
3. Scan the appropriate digits from the keypad in [Appendix C](#) that represent the hex designation for the desired character. A table containing the [ASCII Character Set](#) and their corresponding Hex Values is available in the inside back cover of this manual. ASCII parameters must be input by scanning a pair of hexadecimal digits for the desired character. For example, if ASCII "A" were the desired ACK character, you would scan the digits "4", then "1" (the ASCII corresponding hex value).
4. The scanner will automatically exit Programming Mode when the appropriate amount of digits/characters have been scanned.



SET RS-232 ACK CHARACTER

RS-232 NAK Character

This feature specifies which ASCII character will be used as a NAK character.

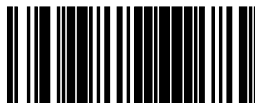


NOTE

DO NOT set this feature to use previously defined characters such as XON, XOFF or host commands as this will conflict with normal operation of these characters. 8-bit data is not recognized when the feature, RS-232 Number of Data Bits, is set to 7 data bits.

To specify the RS-232 NAK Character:

1. Scan the SWITCH bar code.
2. Scan the bar code, **SET RS-232 NAK CHARACTER** below. You'll need to cover any unused bar codes on this and the facing page to ensure the scanner reads only the bar code you intend to scan.
3. Scan the appropriate digits from the keypad in **Appendix C** that represent the hex designation for the desired character. A table containing the **ASCII Character Set** and their corresponding Hex Values is available in the inside back cover of this manual. ASCII parameters must be input by scanning a pair of hexadecimal digits for the desired character. For example, if ASCII "A" were the desired NAK character, you would scan the digits "4", then "1" (the ASCII corresponding hex value).
4. The scanner will automatically exit Programming Mode when the appropriate amount of digits/characters have been scanned.



SET RS-232 NAK CHARACTER

RS-232 Retry on ACK NAK Timeout

This option specifies the action scanner performs on expiration of the [RS-232 ACK NAK Timeout Value](#).

To set this feature:

1. Scan the SWITCH bar code.
2. Scan either the enable or disable bar code below. You'll need to cover any unused bar codes on this and the facing page to ensure that the scanner reads only the bar code you intend to scan.
3. Complete the programming sequence by scanning the SWITCH bar code.



RS-232 RETRY ON ACK NAK TIMEOUT = DISABLE



RS-232 RETRY ON ACK NAK TIMEOUT = ENABLE

RS-232 ACK NAK Timeout Value

This item specifies the time the scanner will wait for an ACK character from the host following a label transmission.

- 0 = Infinite timeout
- 1 - 75 = Timeout in 200-millisecond increments

To set the ACK NAK Timeout Value:

1. Scan the SWITCH bar code.
2. Scan the bar code below, **SET RS-232 ACK NAK TIMEOUT VALUE**. You'll need to cover any unused bar codes on this and the facing page to ensure that the scanner reads only the bar code you intend to scan.
3. Scan the appropriate digits from the keypad in **Appendix C** that represent the desired timeout. A setting of 0 specifies an infinite timeout. The remaining selectable range is 1-75, which is the timeout in 200-millisecond increments. Pad all single digit numbers with leading zeroes to yield a three-digit entry (000-075).

Examples:

000 = Infinite timeout

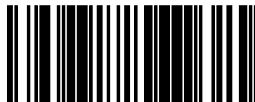
001 = 200ms

005 = 1,000ms (1 second)

040 = 8,000ms (8 seconds)

075 = 15,000ms (15 seconds)

4. The scanner will automatically exit Programming Mode when the appropriate amount of digits have been scanned.



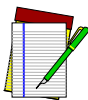
SET RS-232 ACK NAK TIMEOUT VALUE

RS-232 ACK NAK Retry Count

This feature sets the number of times for the scanner to retry a label transmission under a retry condition.

To set the RS-232 ACK NAK Retry Count:

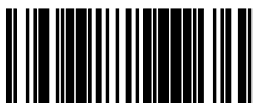
1. Scan the SWITCH bar code.
2. Scan the bar code, [SET RS-232 ACK NAK RETRY COUNT](#) below. You'll need to cover any unused bar codes on this and the facing page to ensure that the scanner reads only the bar code you intend to scan.
3. Scan the appropriate digits from the keypad in [Appendix C](#) that represent the desired number. The selectable range is 0-255 resets. Pad all single and double digit numbers with leading zeroes to yield a three-digit entry (000-255).



NOTE

A setting of 255 specifies “retry forever.”

4. The scanner will automatically exit Programming Mode when the appropriate amount of digits have been scanned.



SET RS-232 ACK NAK RETRY COUNT

RS-232 ACK NAK Error Handling

This item specifies the method the scanner will use to handle errors detected while waiting to receive the ACK character from the host. Errors include unrecognized host commands and communication errors such as parity or framing errors.

- Ignore Errors (recommended setting)
- Assume ACK (risk of lost label data)
- Assume NAK (risk of duplicate label)

To select the option for RS-232 ACK NAK Error Handling:

1. Scan the SWITCH bar code.
2. Scan the desired option from the bar codes below. You'll need to cover any unused bar codes on this and the facing page to ensure that the scanner reads only the bar code you intend to scan.
3. Complete the programming sequence by scanning the SWITCH bar code.



RS-232 ACK NAK ERROR HANDLING = IGNORE ERRORS

RS-232 ACK NAK Error Handling — continued

Remember to cover any unused bar codes on this and the facing page to ensure that the scanner reads only the bar code you intend to scan.



RS-232 ACK NAK ERROR HANDLING = ASSUME ACK



RS-232 ACK NAK ERROR HANDLING = ASSUME NAK

RS-232 Indicate Transmission Failure

Enables/disables an audible error indication upon a transmission failure.



RS-232 INDICATE TRANSMISSION FAILURE = DISABLE



RS-232 INDICATE TRANSMISSION FAILURE = ENABLE

Single Cable RS-232 Options

The RS-232 Single Cable interface shares some configuration options with other RS-232 interfaces. Rather than repeat them in this chapter as Single Cable options, please find them referenced as follows:

- [RS-232 Baud Rate on page 122](#)
- [RS-232 Number of Data Bits on page 126](#)
- [RS-232 Number of Stop Bits on page 127](#)
- [RS-232 Parity on page 128](#)
- [RS-232 Software Flow Control on page 134](#)
- [RS-232 Beep on Not on File on page 142](#)
- [RS-232 Beep on Not on File on page 142](#)

Single Cable Pacesetter Plus Enable

Enables/disables the scanner's ability to send Pacesetter Plus information as trailers to UPC/EAN label data.

To set this feature:

1. Scan the SWITCH bar code.
2. Scan either the enable or disable bar code below. You'll need to cover any unused bar codes on this and the facing page to ensure that the scanner reads only the bar code you intend to scan.
3. Complete the programming sequence by scanning the SWITCH bar code.



SINGLE CABLE PACESETTER PLUS = DISABLE



SINGLE CABLE PACESETTER PLUS = ENABLE

Single Cable RS-232 RTS CTS Selection

Specifies how RTS and CTS are used to control the data flow. RTS is controlled by the Scanner and can be continuously held high/low, or can be asserted during label transmission. The scanner looks at CTS, as the configuration values state, to determine when to send label data.

Choices are:

- Option 0 = RTS is held in low state and CTS is ignored
- Option 1 = RTS is held in high state and CTS is ignored
- Option 2 = Assert RTS and wait for CTS to be asserted
- Option 3 = Assert RTS and ignore CTS
- Option 4 = RTS held low, wait for CTS to be asserted
- Option 5 = RTS held high, wait for CTS to be asserted

To set this feature:

1. Scan the SWITCH bar code.
2. Scan a bar code below or on the following pages representing the desired option. You'll need to cover any unused bar codes, as well as facing pages to ensure that the scanner reads only the bar code you intend to scan.
3. Complete the programming sequence by scanning the SWITCH bar code.



RTS CTS SELECTION = OPTION 0



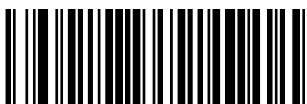
RTS CTS SELECTION = OPTION 1

Single Cable RS-232 RTS CTS Selection — continued

Remember to cover any unused bar codes on this and the facing page to ensure that the scanner reads only the bar code you intend to scan.



RTS CTS SELECTION = OPTION 2



RTS CTS SELECTION = OPTION 3

Single Cable RS-232 RTS CTS Selection — continued

Remember to cover any unused bar codes on this and the facing page to ensure that the scanner reads only the bar code you intend to scan.



RTS CTS SELECTION = OPTION 4



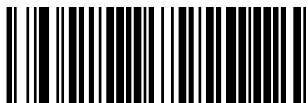
RTS CTS SELECTION = OPTION 5

Single Cable RS-232 Use BCC

Enables/disables the ability of the scanner to use BCC.

To set this feature:

1. Scan the SWITCH bar code.
2. Scan either the enable or disable bar code below. You'll need to cover any unused bar codes on this and the facing page to ensure that the scanner reads only the bar code you intend to scan.
3. Complete the programming sequence by scanning the SWITCH bar code.



SINGLE CABLE RS-232 USE BCC = DISABLE



SINGLE CABLE RS-232 USE BCC = ENABLE

Single Cable RS-232 Use ACK/NAK

Enables/disables the ability of the scanner to use ACK/NAK.

To set this feature:

1. Scan the SWITCH bar code.
2. Scan either the enable or disable bar code below. You'll need to cover any unused bar codes on this and the facing page to ensure that the scanner reads only the bar code you intend to scan.
3. Complete the programming sequence by scanning the SWITCH bar code.



SINGLE CABLE RS-232 USE ACK/NAK = DISABLE



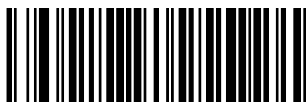
SINGLE CABLE RS-232 USE ACK/NAK = ENABLE

Single Cable RS-232 Use STX

Enables/disables the ability of the scanner to use STX.

To set this feature:

1. Scan the SWITCH bar code.
2. Scan either the enable or disable bar code below. You'll need to cover any unused bar codes on this and the facing page to ensure that the scanner reads only the bar code you intend to scan.
3. Complete the programming sequence by scanning the SWITCH bar code.



SINGLE CABLE RS-232 USE STX = DISABLE



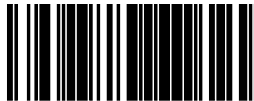
SINGLE CABLE RS-232 USE STX = ENABLE

Set Single Cable RS-232 STX Character

This feature selects the STX character.

To specify the STX Character:

1. Scan the SWITCH bar code.
2. Scan the bar code, **SET SINGLE CABLE RS-232 STX CHARACTER** below. You'll need to cover any unused bar codes on this and the facing page to ensure the scanner reads only the bar code you intend to scan.
3. Scan the appropriate characters/digits from the keypad in **Appendix C** that represent the decimal designation for the desired character. A table containing the **ASCII Character Set** and their corresponding decimal values is available in the inside back cover of this manual. ASCII parameters must be input by scanning decimal digits for each character. Pad all numbers with leading zeroes to yield a three-digit entry (001-127). Thus, to set a single character value of A, bar codes containing the digits '0', '6' and '5' must be scanned. The selectable range for this option is any decimal value from 001 to 127.
4. The scanner will automatically exit Programming Mode when the appropriate amount of digits have been scanned.



SET SINGLE CABLE RS-232 STX CHARACTER

Set Single Cable RS-232 ETX Character

Allows selection of the ETX character.

To specify the ETX Character:

1. Scan the SWITCH bar code.
2. Scan the bar code, **SET SINGLE CABLE RS-232 ETX CHARACTER** below. You'll need to cover any unused bar codes on this and the facing page to ensure the scanner reads only the bar code you intend to scan.
3. Scan the appropriate characters/digits from the keypad in **Appendix C** that represent the decimal designation for the desired character. A table containing the **ASCII Character Set** and their corresponding decimal values is available in the inside back cover of this manual. ASCII parameters must be input by scanning decimal digits for each character. Pad all numbers with leading zeroes to yield a three-digit entry (001-127). Thus, to set a single character value of A, bar codes containing the digits '0', '6' and '5' must be scanned. The selectable range for this option is any decimal value from 001 to 127.
4. The scanner will automatically exit Programming Mode when the appropriate amount of digits have been scanned.



SET SINGLE CABLE RS-232 ETX CHARACTER

Keyboard Wedge/USB Keyboard Features

Features listed in this section apply to both the Keyboard Wedge and USB Keyboard interfaces unless otherwise noted.

Keyboard Interface — Keyboard Layout

This feature specifies the country/language to be supported by the keyboard.

To set this feature:

1. Scan the SWITCH bar code.
2. Scan the appropriate country bar code from the following pages. You'll need to cover any unused bar codes on that and the facing page to ensure that the scanner reads only the bar code you intend to scan.
3. Complete the programming sequence by scanning the SWITCH bar code.



Keyboard Interface — Keyboard Layout — continued

Remember to cover any unused bar codes on this and the facing page to ensure that the scanner reads only the bar code you intend to scan.



KEYBOARD LAYOUT = BRITAIN



KEYBOARD LAYOUT = DENMARK

Keyboard Interface — Keyboard Layout — continued

Remember to cover any unused bar codes on this and the facing page to ensure that the scanner reads only the bar code you intend to scan.



KEYBOARD LAYOUT = FRANCE



KEYBOARD LAYOUT = GERMANY

Keyboard Interface — Keyboard Layout — continued

Remember to cover any unused bar codes on this and the facing page to ensure that the scanner reads only the bar code you intend to scan.



KEYBOARD LAYOUT = ITALY



KEYBOARD LAYOUT = NORWAY

Keyboard Interface — Keyboard Layout — continued

Remember to cover any unused bar codes on this and the facing page to ensure that the scanner reads only the bar code you intend to scan.



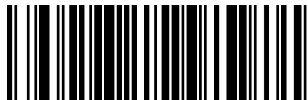
KEYBOARD LAYOUT = PORTUGAL



KEYBOARD LAYOUT = SPAIN

Keyboard Interface — Keyboard Layout — continued

Remember to cover any unused bar codes on this and the facing page to ensure that the scanner reads only the bar code you intend to scan.



KEYBOARD LAYOUT = SWEDEN



KEYBOARD LAYOUT = SWITZERLAND

Keyboard Interface — Keyboard Layout — continued

Remember to cover any unused bar codes on this and the facing page to ensure that the scanner reads only the bar code you intend to scan.



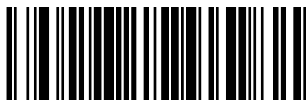
KEYBOARD LAYOUT = JAPANESE 106 KEY



KEYBOARD LAYOUT = HUNGARY

Keyboard Interface — Keyboard Layout — continued

Remember to cover any unused bar codes on this and the facing page to ensure that the scanner reads only the bar code you intend to scan.



KEYBOARD LAYOUT = CZECH



KEYBOARD LAYOUT = SLOVAKIA

Keyboard Interface — Keyboard Layout — continued

Remember to cover any unused bar codes on this and the facing page to ensure that the scanner reads only the bar code you intend to scan.



KEYBOARD LAYOUT = ROMANIA



KEYBOARD LAYOUT = CROATIA

Keyboard Interface — Keyboard Layout — continued

Remember to cover any unused bar codes on this and the facing page to ensure that the scanner reads only the bar code you intend to scan.



Keyboard Interface Quiet Interval

Specifies amount of time to look for keyboard activity before scanner breaks keyboard connection in order to transmit data to host.

To set the Keyboard Interface Quiet Interval:

1. Scan the SWITCH bar code.
2. Scan the bar code below, **SET KEYBOARD INTERFACE QUIET INTERVAL**. You'll need to cover any unused bar codes on this and the facing page to ensure that the scanner reads only the bar code you intend to scan.
3. Scan the appropriate digits from the keypad in **Appendix C** that represent the desired delay. The selectable range is 1-100, which is the interval duration in 10-millisecond increments. Pad all single and double digit numbers with leading zeroes to yield a three-digit entry (001-100).

Examples:

001 = 10ms

005 = 50ms

040 = 400ms

100 = 1,000ms (1 second)

4. The scanner will automatically exit Programming Mode when the appropriate amount of digits have been scanned.



Keyboard Interface Caps Lock State

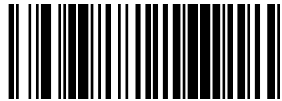
Specifies the format in which the scanner sends character data..

Choices are:

- CAPS LOCK OFF — send character data in normal format.
- CAPS LOCK ON — send character data in reverse case.
- SHIFT LOCK ON — send character data in shifted case. This option only applies to Wedge G. For other interface this setting results in a CAPS LOCK OFF functionality.
- CAPS LOCK COMPENSATION MODE — This only applies to the USB Keyboard Interface. For other interfaces, this setting results in a CAPS LOCK OFF functionality.

To set this feature:

1. Scan the SWITCH bar code.
2. Scan either the enable or disable bar code below. You'll need to cover any unused bar codes on this and the facing page to ensure that the scanner reads only the bar code you intend to scan.
3. Complete the programming sequence by scanning the SWITCH bar code.



CAPS LOCK STATE = OFF



CAPS LOCK STATE = CAPS LOCK ON

Keyboard Interface Caps Lock State — continued

Remember to cover any unused bar codes on this and the facing page to ensure that the scanner reads only the bar code you intend to scan.



CAPS LOCK STATE = SHIFT LOCK ON



CAPS LOCK STATE = CAPS LOCK COMPENSATION MODE

Keyboard Interface — Keyboard Simulation

Enables/disables ability of scanner to perform host communications normally performed by attached keyboard.



This feature does not apply to the USB Keyboard interface.

NOTE

All PCs check the keyboard status during the power-on Selftest. It is recommended that you enable this function if you are working without a keyboard installation. It simulates keyboard timing and passes the keyboard status to the PC during power-on.

To set this feature:

1. Scan the SWITCH bar code.
2. Scan either the enable or disable bar code below. You'll need to cover any unused bar codes on this and the facing page to ensure that the scanner reads only the bar code you intend to scan.
3. Complete the programming sequence by scanning the SWITCH bar code.



KEYBOARD SIMULATION = DISABLE



KEYBOARD SIMULATION = ENABLE

Keyboard Interface — Control Characters

Specifies how the scanner transmits ASCII control characters to the host.



This feature does not apply to the USB Keyboard interface.

NOTE

Choices are:

- Disable Control Characters
- Enable transmission of control characters to host
- Send characters between 00H and 1FH according to a special function-key mapping table. (This is used to send keys that are not in the normal ASCII set; a unique set is provided for each available scancode set. Reference [Appendix F, Keyboard Function Key Mappings.](#))

To set this feature:

1. Scan the SWITCH bar code.
2. Scan your choice from the Control Characters feature bar codes below. You'll need to cover any unused bar codes on this and the facing page to ensure that the scanner reads only the bar code you intend to scan.
3. Complete the programming sequence by scanning the SWITCH bar code.



CONTROL CHARACTERS = DISABLE

Keyboard Interface — Control Characters — continued

Remember to cover any unused bar codes on this and the facing page to ensure that the scanner reads only the bar code you intend to scan.



CONTROL CHARACTERS = ENABLE TRANSMISSION OF CTL CHARACTERS



CONTROL CHARACTERS = ENABLE FUNCTION KEY MAPPING

Keyboard Interface — Intercharacter Delay

Sets the delay between the end of one character and the beginning of the next, in 10 millisecond increments.

To specify the intercharacter delay:

1. Scan the SWITCH bar code.
2. Scan the bar code below, **SET KEYBOARD WEDGE INTERCHARACTER DELAY**. You'll need to cover any unused bar codes on this and the facing page to ensure that the scanner reads only the bar code you intend to scan.
3. Scan the appropriate digits from the keypad in **Appendix C** that represent the desired delay. The selectable range is 0-100, which is the delay in 10-millisecond increments. Pad all single and double digit numbers with leading zeroes to yield a three-digit entry (000-100).

Examples:

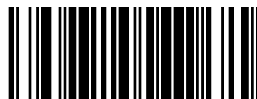
001 = 10ms

005 = 50ms

040 = 400ms

100 = 1,000ms (1 second)

4. The scanner will automatically exit Programming Mode when the appropriate amount of digits have been scanned.



SET KEYBOARD WEDGE INTERCHARACTER DELAY

Symbology Programming



NOTE

If the scanner's interface type must be changed, always be sure that interface configuration is the **FIRST** item scanned during a programming session. (Selecting an interface type resets **ALL** other configuration items — including symbology programming — to the factory default for that interface type.)

Coupon Control

Used to control the method of processing coupon labels.

Options are:

- Disable coupon decoding
- Enable UPC/EAN coupon decoding
- Enable RSS coupon decoding

To set this feature:

1. Scan the SWITCH bar code.
2. Scan either the enable or disable bar code below. You'll need to cover any unused bar codes on this and the facing page to ensure that the scanner reads only the bar code you intend to scan.
3. Complete the programming sequence by scanning the SWITCH bar code.



COUPON CONTROL = DISABLE

Coupon Control — continued

Remember to cover any unused bar codes on this and the facing page to ensure that the scanner reads only the bar code you intend to scan.



COUPON CONTROL = ENABLE UPC/EAN COUPON DECODING



COUPON CONTROL = ENABLE DATABAR COUPON DECODING

UPC-A Enable

Enables/disables the ability of the scanner to decode UPC-A labels.

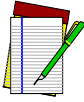
To set this feature:

1. Scan the SWITCH bar code.
2. Scan either the enable or disable bar code below. You'll need to cover any unused bar codes on this and the facing page to ensure that the scanner reads only the bar code you intend to scan.
3. Complete the programming sequence by scanning the SWITCH bar code.



UPC-A Number System Character Transmission

Enables/disables transmission of a UPC-A number system character.



This feature MUST be enabled for IBM interfaces for proper function.

NOTE

To set this feature:

1. Scan the SWITCH bar code.
2. Scan either the enable or disable bar code below. You'll need to cover any unused bar codes on this and the facing page to ensure that the scanner reads only the bar code you intend to scan.
3. Complete the programming sequence by scanning the SWITCH bar code.



UPC-A NUMBER SYSTEM CHARACTER TRANSMISSION = DISABLE



UPC-A NUMBER SYSTEM CHARACTER TRANSMISSION = ENABLE

UPC-A Check Character Transmission

Enables/disables transmission of a UPC-A check character.

To set this feature:

1. Scan the SWITCH bar code.
2. Scan either the enable or disable bar code below. You'll need to cover any unused bar codes on this and the facing page to ensure that the scanner reads only the bar code you intend to scan.
3. Complete the programming sequence by scanning the SWITCH bar code.



UPC-A CHECK CHARACTER TRANSMISSION = DISABLE



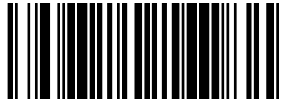
UPC-A CHECK CHARACTER TRANSMISSION = ENABLE

Expand UPC-A to EAN-13

Enables/disables expansion of UPC-A labels to EAN/JAN-13.

To set this feature:

1. Scan the SWITCH bar code.
2. Scan either the enable or disable bar code below. You'll need to cover any unused bar codes on this and the facing page to ensure that the scanner reads only the bar code you intend to scan.
3. Complete the programming sequence by scanning the SWITCH bar code.



EXPAND UPC-A TO EAN/JAN-13 = DISABLE



EXPAND UPC-A TO EAN/JAN-13 = ENABLE

UPC-A Label ID

This feature specifies a UPC-A label ID to be added to bar code data.

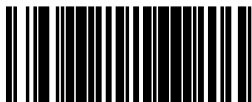


The programming feature, Label ID Control, designates whether the Label ID is transmitted as a prefix or suffix or if Label ID is disabled.

NOTE

To set this feature:

1. Scan the SWITCH bar code.
2. Scan the bar code, [SET UPC-A LABEL ID](#) below. You'll need to cover any unused bar codes on this and the facing page to ensure the scanner reads only the bar code you intend to scan.
3. Scan the appropriate digits from the keypad in [Appendix C](#) that represent the desired Label ID characters; entered as two hex pairs. A table containing the [ASCII Character Set](#) and their corresponding Hex Values is available in the inside back cover of this manual. ASCII parameters must be input by scanning a pair of hexadecimal digits for each character. Thus, to set a two-character value of AB, bar codes containing the digits '4', '1', '4', and '2' must be scanned. The selectable range for this option is any hex value from 00 to FF.
4. Complete the programming sequence by scanning the SWITCH bar code.



SET UPC-A LABEL ID

UPC-A 2-Digit Supplemental Label ID

This feature specifies a UPC-A 2-Digit Supplemental label ID to be added to bar code data.



The programming feature, **Label ID Control**, designates whether the **Label ID** is transmitted as a prefix or suffix or if **Label ID** is disabled.

NOTE

To set this feature:

1. Scan the SWITCH bar code.
2. Scan the bar code, [SET UPC-A 2-DIGIT SUPPLEMENTAL LABEL ID](#) below. You'll need to cover any unused bar codes on this and the facing page to ensure the scanner reads only the bar code you intend to scan.
3. Scan the appropriate digits from the keypad in [Appendix C](#) that represent the desired Label ID characters; entered as two hex pairs. A table containing the [ASCII Character Set](#) and their corresponding Hex Values is available in the inside back cover of this manual. ASCII parameters must be input by scanning a pair of hexadecimal digits for each character. Thus, to set a two-character value of AB, bar codes containing the digits '4', '1', '4', and '2' must be scanned. The selectable range for this option is any hex value from 00 to FF.
4. Complete the programming sequence by scanning the SWITCH bar code.



SET UPC-A 2-DIGIT SUPPLEMENTAL LABEL ID

UPC-A 5-Digit Supplemental Label ID

This feature specifies a UPC-A 5-Digit Supplemental label ID to be added to bar code data.



NOTE

The programming feature, **Label ID Control**, designates whether the Label ID is transmitted as a prefix or suffix or if Label ID is disabled.

To set this feature:

1. Scan the SWITCH bar code.
2. Scan the bar code, [SET UPC-A 5-DIGIT SUPPLEMENTAL LABEL ID](#) below. You'll need to cover any unused bar codes on this and the facing page to ensure the scanner reads only the bar code you intend to scan.
3. Scan the appropriate digits from the keypad in [Appendix C](#) that represent the desired Label ID characters; entered as two hex pairs. A table containing the [ASCII Character Set](#) and their corresponding Hex Values is available in the inside back cover of this manual. ASCII parameters must be input by scanning a pair of hexadecimal digits for each character. Thus, to set a two-character value of AB, bar codes containing the digits '4', '1', '4', and '2' must be scanned. The selectable range for this option is any hex value from 00 to FF.
4. Complete the programming sequence by scanning the SWITCH bar code.



SET UPC-A 5-DIGIT SUPPLEMENTAL LABEL ID

UPC-A 128 Supplemental Label ID

This feature specifies a UPC-A 128 Supplemental label ID to be added to bar code data.

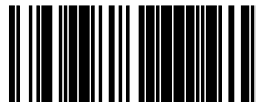


The programming feature, Label ID Control, designates whether the Label ID is transmitted as a prefix or suffix or if Label ID is disabled.

NOTE

To set this feature:

1. Scan the SWITCH bar code.
2. Scan the bar code, [SET UPC-A 128 SUPPLEMENTAL LABEL ID](#) below. You'll need to cover any unused bar codes on this and the facing page to ensure the scanner reads only the bar code you intend to scan.
3. Scan the appropriate digits from the keypad in [Appendix C](#) that represent the desired Label ID characters; entered as two hex pairs. A table containing the [ASCII Character Set](#) and their corresponding Hex Values is available in the inside back cover of this manual. ASCII parameters must be input by scanning a pair of hexadecimal digits for each character. Thus, to set a two-character value of AB, bar codes containing the digits '4', '1', '4', and '2' must be scanned. The selectable range for this option is any hex value from 00 to FF.
4. Complete the programming sequence by scanning the SWITCH bar code.



SET UPC-A 128 SUPPLEMENTAL LABEL ID

UPC-A Minimum Reads

Specifies the minimum number of consecutive times a UPC-A label must be decoded before it is accepted as a good read.

To set this feature:

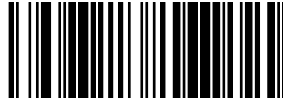
1. Scan the SWITCH bar code.
2. Scan the bar code representing the desired option below or on the following pages. You'll need to cover any unused bar codes on facing pages to ensure that the scanner reads only the bar code you intend to scan.

Complete the programming sequence by scanning the SWITCH bar code.



UPC-A Minimum Reads — continued

Remember to cover any unused bar codes on this and the facing page to ensure that the scanner reads only the bar code you intend to scan.



UPC-A MINIMUM READS = 3



UPC-A MINIMUM READS = 4

UPC-E Enable

Enables/disables the ability of the scanner to decode UPC-E labels.

To set this feature:

1. Scan the SWITCH bar code.
2. Scan either the enable or disable bar code below. You'll need to cover any unused bar codes on this and the facing page to ensure that the scanner reads only the bar code you intend to scan.
3. Complete the programming sequence by scanning the SWITCH bar code.

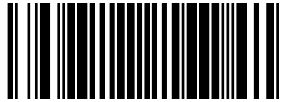


UPC-E Number System Character Transmission

Enables/disables transmission of a UPC-E number system character.

To set this feature:

1. Scan the SWITCH bar code.
2. Scan either the enable or disable bar code below. You'll need to cover any unused bar codes on this and the facing page to ensure that the scanner reads only the bar code you intend to scan.
3. Complete the programming sequence by scanning the SWITCH bar code.



UPC-E NUMBER SYSTEM CHARACTER TRANSMISSION = DISABLE



UPC-E NUMBER SYSTEM CHARACTER TRANSMISSION = ENABLE

UPC-E Check Character Transmission

Enables/disables transmission of a UPC-E check character.

To set this feature:

1. Scan the SWITCH bar code.
2. Scan either the enable or disable bar code below. You'll need to cover any unused bar codes on this and the facing page to ensure that the scanner reads only the bar code you intend to scan.
3. Complete the programming sequence by scanning the SWITCH bar code.



UPC-E CHECK CHARACTER TRANSMISSION = DISABLE



UPC-E CHECK CHARACTER TRANSMISSION = ENABLE

Expand UPC-E to UPC-A

Enables/disables expansion of UPC-E labels to UPC-A.

To set this feature:

1. Scan the SWITCH bar code.
2. Scan either the enable or disable bar code below. You'll need to cover any unused bar codes on this and the facing page to ensure that the scanner reads only the bar code you intend to scan.
3. Complete the programming sequence by scanning the SWITCH bar code.



EXPAND UPC-E TO UPC-A = DISABLE



EXPAND UPC-E TO UPC-A = ENABLE

Expand UPC-E to EAN-13

Enables/disables expansion of UPC-E labels to EAN/JAN-13.

To set this feature:

1. Scan the SWITCH bar code.
2. Scan either the enable or disable bar code below. You'll need to cover any unused bar codes on this and the facing page to ensure that the scanner reads only the bar code you intend to scan.
3. Complete the programming sequence by scanning the SWITCH bar code.



EXPAND UPC-E TO EAN/JAN-13 = DISABLE



EXPAND UPC-E TO EAN/JAN-13 = ENABLE

UPC-E Label ID

This feature specifies a UPC-E label ID to be added to bar code data.

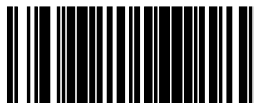


The programming feature, Label ID Control, designates whether the Label ID is transmitted as a prefix or suffix or if Label ID is disabled.

NOTE

To set this feature:

1. Scan the SWITCH bar code.
2. Scan the bar code, [SET UPC-E LABEL ID](#) below. You'll need to cover any unused bar codes on this and the facing page to ensure the scanner reads only the bar code you intend to scan.
3. Scan the appropriate digits from the keypad in [Appendix C](#) that represent the desired Label ID characters; entered as two hex pairs. A table containing the [ASCII Character Set](#) and their corresponding Hex Values is available in the inside back cover of this manual. ASCII parameters must be input by scanning a pair of hexadecimal digits for each character. Thus, to set a two-character value of AB, bar codes containing the digits '4', '1', '4', and '2' must be scanned. The selectable range for this option is any hex value from 00 to FF.
4. Complete the programming sequence by scanning the SWITCH bar code.



SET UPC-E LABEL ID

UPC-E 2-Digit Supplemental Label ID

This feature specifies a UPC-E 2-Digit Supplemental label ID to be added to bar code data.



The programming feature, **Label ID Control**, designates whether the Label ID is transmitted as a prefix or suffix or if Label ID is disabled.

NOTE

To set this feature:

1. Scan the SWITCH bar code.
2. Scan the bar code, [SET UPC-E 2-DIGIT SUPPLEMENTAL LABEL ID](#) below. You'll need to cover any unused bar codes on this and the facing page to ensure the scanner reads only the bar code you intend to scan.
3. Scan the appropriate digits from the keypad in [Appendix C](#) that represent the desired Label ID characters; entered as two hex pairs. A table containing the [ASCII Character Set](#) and their corresponding Hex Values is available in the inside back cover of this manual. ASCII parameters must be input by scanning a pair of hexadecimal digits for each character. Thus, to set a two-character value of AB, bar codes containing the digits '4', '1', '4', and '2' must be scanned. The selectable range for this option is any hex value from 00 to FF.
4. Complete the programming sequence by scanning the SWITCH bar code.



SET UPC-E 2-DIGIT SUPPLEMENTAL LABEL ID

UPC-E 5-Digit Supplemental Label ID

This feature specifies a UPC-E 5-Digit Supplemental label ID to be added to bar code data.

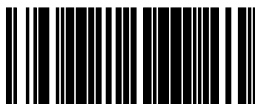


The programming feature, **Label ID Control**, designates whether the Label ID is transmitted as a prefix or suffix or if Label ID is disabled.

NOTE

To set this feature:

1. Scan the SWITCH bar code.
2. Scan the bar code, [SET UPC-E 5-DIGIT SUPPLEMENTAL LABEL ID](#) below. You'll need to cover any unused bar codes on this and the facing page to ensure the scanner reads only the bar code you intend to scan.
3. Scan the appropriate digits from the keypad in [Appendix C](#) that represent the desired Label ID characters; entered as two hex pairs. A table containing the [ASCII Character Set](#) and their corresponding Hex Values is available in the inside back cover of this manual. ASCII parameters must be input by scanning a pair of hexadecimal digits for each character. Thus, to set a two-character value of AB, bar codes containing the digits '4', '1', '4', and '2' must be scanned. The selectable range for this option is any hex value from 00 to FF.
4. Complete the programming sequence by scanning the SWITCH bar code.



SET UPC-E 5-DIGIT SUPPLEMENTAL LABEL ID

UPC-E 128 Supplemental Label ID

This feature specifies a UPC-E 128 Supplemental label ID to be added to bar code data.



The programming feature, Label ID Control, designates whether the Label ID is transmitted as a prefix or suffix or if Label ID is disabled.

NOTE

To set this feature:

1. Scan the SWITCH bar code.
2. Scan the bar code, [SET UPC-E 128 SUPPLEMENTAL LABEL ID](#) below. You'll need to cover any unused bar codes on this and the facing page to ensure the scanner reads only the bar code you intend to scan.
3. Scan the appropriate digits from the keypad in [Appendix C](#) that represent the desired Label ID characters; entered as two hex pairs. A table containing the [ASCII Character Set](#) and their corresponding Hex Values is available in the inside back cover of this manual. ASCII parameters must be input by scanning a pair of hexadecimal digits for each character. Thus, to set a two-character value of AB, bar codes containing the digits '4', '1', '4', and '2' must be scanned. The selectable range for this option is any hex value from 00 to FF.
4. Complete the programming sequence by scanning the SWITCH bar code.



SET UPC-E 128 SUPPLEMENTAL LABEL ID

UPC-E Minimum Reads

Specifies the minimum number of consecutive times a UPC-E label must be decoded before it is accepted as a good read.

To set this feature:

1. Scan the SWITCH bar code.
2. Scan the bar code representing the desired option below or on the following pages. You'll need to cover any unused bar codes on facing pages to ensure that the scanner reads only the bar code you intend to scan.

Complete the programming sequence by scanning the SWITCH bar code.



UPC-E Minimum Reads — continued

Remember to cover any unused bar codes on this and the facing page to ensure that the scanner reads only the bar code you intend to scan.



UPC-E MINIMUM READS = 3



UPC-E MINIMUM READS = 4

EAN-13 Enable

Enables/disables the ability of the scanner to decode EAN/JAN-13 labels.

To set this feature:

1. Scan the SWITCH bar code.
2. Scan either the enable or disable bar code below. You'll need to cover any unused bar codes on this and the facing page to ensure that the scanner reads only the bar code you intend to scan.
3. Complete the programming sequence by scanning the SWITCH bar code.



EAN-13 First Character Transmission

Enables/disables transmission of EAN/JAN-13 first character.

To set this feature:

1. Scan the SWITCH bar code.
2. Scan either the enable or disable bar code below. You'll need to cover any unused bar codes on this and the facing page to ensure that the scanner reads only the bar code you intend to scan.
3. Complete the programming sequence by scanning the SWITCH bar code.



EAN-13 FIRST CHARACTER TRANSMISSION = DISABLE



EAN-13 FIRST CHARACTER TRANSMISSION = ENABLE

EAN-13 Check Character Transmission

Enables/disables transmission of an EAN/JAN-13 check character.

To set this feature:

1. Scan the SWITCH bar code.
2. Scan either the enable or disable bar code below. You'll need to cover any unused bar codes on this and the facing page to ensure that the scanner reads only the bar code you intend to scan.
3. Complete the programming sequence by scanning the SWITCH bar code.



EAN-13 CHECK CHARACTER TRANSMISSION = DISABLE



EAN-13 CHECK CHARACTER TRANSMISSION = ENABLE

EAN-13 ISBN Conversion Enable

Enables/disables conversion of EAN/JAN-13 labels starting with 978 to Bookland ISBN labels.



NOTE

If any add-on information is present on the label prior to the conversion to ISBN, the add-on data will be discarded. Only the base label will be converted.

To set this feature:

1. Scan the SWITCH bar code.
2. Scan either the enable or disable bar code below. You'll need to cover any unused bar codes on this and the facing page to ensure that the scanner reads only the bar code you intend to scan.
3. Complete the programming sequence by scanning the SWITCH bar code.



EAN-13 ISBN Conversion= DISABLE



EAN-13 ISBN Conversion = ENABLE

EAN 13 Label ID

This feature specifies an EAN 13 label ID to be added to bar code data.

To set this feature:

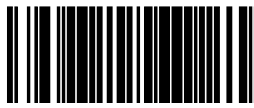


The programming feature, Label ID Control, designates whether the Label ID is transmitted as a prefix or suffix or if Label ID is disabled.

NOTE

To set this feature:

1. Scan the SWITCH bar code.
2. Scan the bar code, [SET EAN 13 LABEL ID](#) below. You'll need to cover any unused bar codes on this and the facing page to ensure the scanner reads only the bar code you intend to scan.
3. Scan the appropriate digits from the keypad in [Appendix C](#) that represent the desired Label ID characters; entered as two hex pairs. A table containing the [ASCII Character Set](#) and their corresponding Hex Values is available in the inside back cover of this manual. ASCII parameters must be input by scanning a pair of hexadecimal digits for each character. Thus, to set a two-character value of AB, bar codes containing the digits '4', '1', '4', and '2' must be scanned. The selectable range for this option is any hex value from 00 to FF.
4. Complete the programming sequence by scanning the SWITCH bar code.



SET EAN 13 LABEL ID

EAN-13 2-Digit Supplemental Label ID

This feature specifies an EAN-13 2-Digit Supplemental label ID to be added to bar code data.

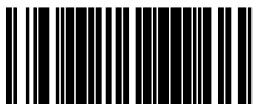


The programming feature, **Label ID Control**, designates whether the Label ID is transmitted as a prefix or suffix or if Label ID is disabled.

NOTE

To set this feature:

1. Scan the SWITCH bar code.
2. Scan the bar code, **SET EAN-13 2-DIGIT SUPPLEMENTAL LABEL ID** below. You'll need to cover any unused bar codes on this and the facing page to ensure the scanner reads only the bar code you intend to scan.
3. Scan the appropriate digits from the keypad in **Appendix C** that represent the desired Label ID characters; entered as two hex pairs. A table containing the **ASCII Character Set** and their corresponding Hex Values is available in the inside back cover of this manual. ASCII parameters must be input by scanning a pair of hexadecimal digits for each character. Thus, to set a two-character value of AB, bar codes containing the digits '4', '1', '4', and '2' must be scanned. The selectable range for this option is any hex value from 00 to FF.
4. Complete the programming sequence by scanning the SWITCH bar code.



SET EAN-13 2-DIGIT SUPPLEMENTAL LABEL ID

EAN-13 5-Digit Supplemental Label ID

This feature specifies an EAN-13 5-Digit Supplemental label ID to be added to bar code data.

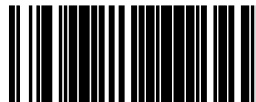


The programming feature, **Label ID Control**, designates whether the Label ID is transmitted as a prefix or suffix or if Label ID is disabled.

NOTE

To set this feature:

1. Scan the SWITCH bar code.
2. Scan the bar code, **SET EAN-13 5-DIGIT SUPPLEMENTAL LABEL ID** below. You'll need to cover any unused bar codes on this and the facing page to ensure the scanner reads only the bar code you intend to scan.
3. Scan the appropriate digits from the keypad in **Appendix C** that represent the desired Label ID characters; entered as two hex pairs. A table containing the **ASCII Character Set** and their corresponding Hex Values is available in the inside back cover of this manual. ASCII parameters must be input by scanning a pair of hexadecimal digits for each character. Thus, to set a two-character value of AB, bar codes containing the digits '4', '1', '4', and '2' must be scanned. The selectable range for this option is any hex value from 00 to FF.
4. Complete the programming sequence by scanning the SWITCH bar code.



SET EAN-13 5-DIGIT SUPPLEMENTAL LABEL ID

EAN-13 128 Supplemental Label ID

This feature specifies an EAN-13 128 Supplemental label ID to be added to bar code data.



The programming feature, **Label ID Control**, designates whether the Label ID is transmitted as a prefix or suffix or if Label ID is disabled.

NOTE

To set this feature:

1. Scan the SWITCH bar code.
2. Scan the bar code, **SET EAN-13 128 SUPPLEMENTAL LABEL ID = DISABLE** below. You'll need to cover any unused bar codes on this and the facing page to ensure the scanner reads only the bar code you intend to scan.
3. Scan the appropriate digits from the keypad in **Appendix C** that represent the desired Label ID characters; entered as two hex pairs. A table containing the **ASCII Character Set** and their corresponding Hex Values is available in the inside back cover of this manual. ASCII parameters must be input by scanning a pair of hexadecimal digits for each character. Thus, to set a two-character value of AB, bar codes containing the digits '4', '1', '4', and '2' must be scanned. The selectable range for this option is any hex value from 00 to FF.
4. Complete the programming sequence by scanning the SWITCH bar code.



SET EAN-13 128 SUPPLEMENTAL LABEL ID = DISABLE

EAN-13 Minimum Reads

Specifies the minimum number of consecutive times an EAN-13 label must be decoded before it is accepted as a good read.

To set this feature:

1. Scan the SWITCH bar code.
2. Scan the bar code representing the desired option below or on the following pages. You'll need to cover any unused bar codes on facing pages to ensure that the scanner reads only the bar code you intend to scan.

Complete the programming sequence by scanning the SWITCH bar code.



EAN-13 Minimum Reads — continued

Remember to cover any unused bar codes on this and the facing page to ensure that the scanner reads only the bar code you intend to scan.



EAN-13 MINIMUM READS = 3



EAN-13 MINIMUM READS = 4

Bookland Label ID

This feature specifies a Bookland label ID to be added to bar code data.



The programming feature, Label ID Control, designates whether the Label ID is transmitted as a prefix or suffix or if Label ID is disabled.

NOTE

To set this feature:

1. Scan the SWITCH bar code.
2. Scan the bar code, [SET BOOKLAND LABEL ID](#) below. You'll need to cover any unused bar codes on this and the facing page to ensure the scanner reads only the bar code you intend to scan.
3. Scan the appropriate digits from the keypad in [Appendix C](#) that represent the desired Label ID characters; entered as two hex pairs. A table containing the [ASCII Character Set](#) and their corresponding Hex Values is available in the inside back cover of this manual. ASCII parameters must be input by scanning a pair of hexadecimal digits for each character. Thus, to set a two-character value of AB, bar codes containing the digits '4', '1', '4', and '2' must be scanned. The selectable range for this option is any hex value from 00 to FF.
4. Complete the programming sequence by scanning the SWITCH bar code.



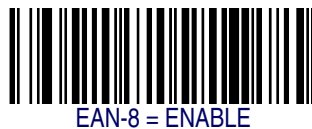
SET BOOKLAND LABEL ID

EAN-8 Enable

Enables/disables the ability of the scanner to decode EAN/JAN-8 labels.

To set this feature:

1. Scan the SWITCH bar code.
2. Scan either the enable or disable bar code below. You'll need to cover any unused bar codes on this and the facing page to ensure that the scanner reads only the bar code you intend to scan.
3. Complete the programming sequence by scanning the SWITCH bar code.



EAN-8 Check Character Transmission

Enables/disables transmission of an EAN/JAN-8 check character.

To set this feature:

1. Scan the SWITCH bar code.
2. Scan either the enable or disable bar code below. You'll need to cover any unused bar codes on this and the facing page to ensure that the scanner reads only the bar code you intend to scan.
3. Complete the programming sequence by scanning the SWITCH bar code.



EAN-8 CHECK CHARACTER TRANSMISSION = DISABLE



EAN-8 CHECK CHARACTER TRANSMISSION = ENABLE

Expand EAN-8 to EAN-13

Enables/disables expansion of EAN/JAN-8 labels to EAN/JAN-13.

To set this feature:

1. Scan the SWITCH bar code.
2. Scan either the enable or disable bar code below. You'll need to cover any unused bar codes on this and the facing page to ensure that the scanner reads only the bar code you intend to scan.
3. Complete the programming sequence by scanning the SWITCH bar code.



EXPAND EAN/JAN-8 TO EAN/JAN-13 = DISABLE



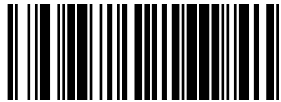
EXPAND EAN/JAN-8 TO EAN/JAN-13 = ENABLE

EAN-8/JAN-8 Guard Insertion

Enables/Disables the ability of the scanner to insert a guard pattern into an otherwise complete EAN-8 segment it has received.

To set this feature:

1. Scan the SWITCH bar code.
2. Scan either the enable or disable bar code below. You'll need to cover any unused bar codes on this and the facing page to ensure that the scanner reads only the bar code you intend to scan.
3. Complete the programming sequence by scanning the SWITCH bar code.



EAN-8/JAN-8 GUARD INSERTION = DISABLE



EAN-8/JAN-8 GUARD INSERTION = ENABLE

EAN-8/JAN-8 Guard Substitution

Enables/disables the ability of the scanner to substitute a guard pattern for even-parity 6 when an EAN-8/JAN-8 label is presented.

To set this feature:

1. Scan the SWITCH bar code.
2. Scan either the enable or disable bar code below. You'll need to cover any unused bar codes on this and the facing page to ensure that the scanner reads only the bar code you intend to scan.
3. Complete the programming sequence by scanning the SWITCH bar code.



EAN-8/JAN-8 GUARD SUBSTITUTION = DISABLE



EAN-8/JAN-8 GUARD SUBSTITUTION = ENABLE

EAN-8/JAN-8 Both Guards Substitution

Enables/disables the ability of the scanner to find an EAN/JAN8 guard pattern in cases where the EAN/JAN8 margin makes the guard look like a character.

To set this feature:

1. Scan the SWITCH bar code.
2. Scan either the enable or disable bar code below. You'll need to cover any unused bar codes on this and the facing page to ensure that the scanner reads only the bar code you intend to scan.
3. Complete the programming sequence by scanning the SWITCH bar code.



EAN-8/JAN-8 BOTH GUARDS SUBSTITUTION = DISABLE



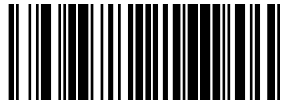
EAN-8/JAN-8 BOTH GUARDS SUBSTITUTION = ENABLE

EAN-8 Stitch Exact Label Halves

When enabled, this allows the scanner the ability to stitch exact EAN-8 label halves with no overlapping characters.

To set this feature:

1. Scan the SWITCH bar code.
2. Scan either the enable or disable bar code below. You'll need to cover any unused bar codes on this and the facing page to ensure that the scanner reads only the bar code you intend to scan.
3. Complete the programming sequence by scanning the SWITCH bar code.



EAN-8 STITCH EXACT LABEL HALVES = DISABLE



EAN-8 STITCH EXACT LABEL HALVES = ENABLE

EAN-8 Stitch Unlike Label Halves

When enabled, this allows the scanner the ability to stitch two EAN-8 label halves together that may contain differing characters.

To set this feature:

1. Scan the SWITCH bar code.
2. Scan either the enable or disable bar code below. You'll need to cover any unused bar codes on this and the facing page to ensure that the scanner reads only the bar code you intend to scan.
3. Complete the programming sequence by scanning the SWITCH bar code.



EAN-8 STITCH UNLIKE LABEL HALVES = DISABLE



EAN-8 STITCH UNLIKE LABEL HALVES = ENABLE

EAN 8 Label ID

This feature specifies an EAN 8 label ID to be added to bar code data.

To set this feature:

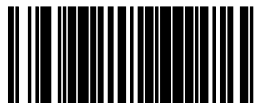


NOTE

The programming feature, **Label ID Control**, designates whether the Label ID is transmitted as a prefix or suffix or if Label ID is disabled.

To set this feature:

1. Scan the SWITCH bar code.
2. Scan the bar code, **SET EAN 8 LABEL ID** below. You'll need to cover any unused bar codes on this and the facing page to ensure the scanner reads only the bar code you intend to scan.
3. Scan the appropriate digits from the keypad in **Appendix C** that represent the desired Label ID characters; entered as two hex pairs. A table containing the **ASCII Character Set** and their corresponding Hex Values is available in the inside back cover of this manual. ASCII parameters must be input by scanning a pair of hexadecimal digits for each character. Thus, to set a two-character value of AB, bar codes containing the digits '4', '1', '4', and '2' must be scanned. The selectable range for this option is any hex value from 00 to FF.
4. Complete the programming sequence by scanning the SWITCH bar code.



SET EAN 8 LABEL ID

EAN-8 2-Digit Supplemental Label ID

This feature specifies an EAN-8 2-Digit Supplemental label ID to be added to bar code data.

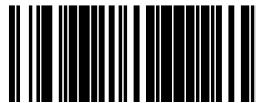


The programming feature, **Label ID Control**, designates whether the Label ID is transmitted as a prefix or suffix or if Label ID is disabled.

NOTE

To set this feature:

1. Scan the SWITCH bar code.
2. Scan the bar code, **SET EAN-8 2-DIGIT SUPPLEMENTAL LABEL ID** below. You'll need to cover any unused bar codes on this and the facing page to ensure the scanner reads only the bar code you intend to scan.
3. Scan the appropriate digits from the keypad in **Appendix C** that represent the desired Label ID characters; entered as two hex pairs. A table containing the **ASCII Character Set** and their corresponding Hex Values is available in the inside back cover of this manual. ASCII parameters must be input by scanning a pair of hexadecimal digits for each character. Thus, to set a two-character value of AB, bar codes containing the digits '4', '1', '4', and '2' must be scanned. The selectable range for this option is any hex value from 00 to FF.
4. Complete the programming sequence by scanning the SWITCH bar code.



SET EAN-8 2-DIGIT SUPPLEMENTAL LABEL ID

EAN-8 5-Digit Supplemental Label ID

This feature specifies an EAN-8 5-Digit Supplemental label ID to be added to bar code data.

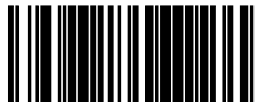


The programming feature, **Label ID Control**, designates whether the Label ID is transmitted as a prefix or suffix or if Label ID is disabled.

NOTE

To set this feature:

1. Scan the SWITCH bar code.
2. Scan the bar code, **SET EAN-8 5-DIGIT SUPPLEMENTAL LABEL ID** below. You'll need to cover any unused bar codes on this and the facing page to ensure the scanner reads only the bar code you intend to scan.
3. Scan the appropriate digits from the keypad in **Appendix C** that represent the desired Label ID characters; entered as two hex pairs. A table containing the **ASCII Character Set** and their corresponding Hex Values is available in the inside back cover of this manual. ASCII parameters must be input by scanning a pair of hexadecimal digits for each character. Thus, to set a two-character value of AB, bar codes containing the digits '4', '1', '4', and '2' must be scanned. The selectable range for this option is any hex value from 00 to FF.
4. Complete the programming sequence by scanning the SWITCH bar code.



SET EAN-8 5-DIGIT SUPPLEMENTAL LABEL ID

EAN-8 128 Supplemental Label ID

This feature specifies an EAN-8 128 Supplemental label ID to be added to bar code data.



The programming feature, **Label ID Control**, designates whether the Label ID is transmitted as a prefix or suffix or if Label ID is disabled.

NOTE

To set this feature:

1. Scan the SWITCH bar code.
2. Scan the bar code, **SET EAN-8 128 SUPPLEMENTAL LABEL ID** below. You'll need to cover any unused bar codes on this and the facing page to ensure the scanner reads only the bar code you intend to scan.
3. Scan the appropriate digits from the keypad in **Appendix C** that represent the desired Label ID characters; entered as two hex pairs. A table containing the **ASCII Character Set** and their corresponding Hex Values is available in the inside back cover of this manual. ASCII parameters must be input by scanning a pair of hexadecimal digits for each character. Thus, to set a two-character value of AB, bar codes containing the digits '4', '1', '4', and '2' must be scanned. The selectable range for this option is any hex value from 00 to FF.
4. Complete the programming sequence by scanning the SWITCH bar code.



SET EAN-8 128 SUPPLEMENTAL LABEL ID

EAN-8 Decoding Levels

Decoding levels allow the decoder to be set to perform at one of four selectable levels:

- Very Conservative — Slower scan time, virtually eliminates misreads. The most secure setting.
- Slightly More Aggressive — Faster scanning, more aggressive, yet minimizes misreads.
- Moderately Aggressive — Even faster scanning, even more aggressive.
- Very Aggressive — Fastest scan speed, most aggressive.



CAUTION

Use caution when setting this feature, as the aggressive settings for this feature allow a higher potential for misreads.

To set this feature:

1. Scan the SWITCH bar code.
2. Scan the bar code representing the desired option on the following pages. You'll need to cover any unused bar codes on facing pages to ensure that the scanner reads only the bar code you intend to scan.
3. Complete the programming sequence by scanning the SWITCH bar code.



NOTE

It is important to note that the default for this feature is the “Slightly More Aggressive” setting. For default settings for other features, see [Appendix E](#).

EAN-8 Decoding Levels — continued

Remember to cover any unused bar codes on this and the facing page to ensure that the scanner reads only the bar code you intend to scan.



EAN-8 DECODING LEVELS = VERY CONSERVATIVE



EAN-8 DECODING LEVELS = SLIGHTLY MORE AGGRESSIVE

EAN-8 Decoding Levels — continued

Remember to cover any unused bar codes on this and the facing page to ensure that the scanner reads only the bar code you intend to scan.



EAN-8 DECODING LEVELS = MODERATELY AGGRESSIVE



EAN-8 DECODING LEVELS = VERY AGGRESSIVE

EAN-8 Minimum Reads

Specifies the minimum number of consecutive times an EAN-8 label must be decoded before it is accepted as a good read.

To set this feature:

1. Scan the SWITCH bar code.
2. Scan the bar code representing the desired option below or on the following pages. You'll need to cover any unused bar codes on facing pages to ensure that the scanner reads only the bar code you intend to scan.

Complete the programming sequence by scanning the SWITCH bar code.



EAN-8 Minimum Reads — continued

Remember to cover any unused bar codes on this and the facing page to ensure that the scanner reads only the bar code you intend to scan.



EAN-8 MINIMUM READS = 3



EAN-8 MINIMUM READS = 4

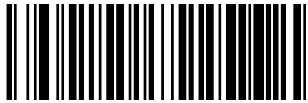
EAN-8 Minimum Segment Length

Specifies the minimum number of characters necessary in an EAN-8/JAN-8 label segment in order for the scanner to accept a label for decoding. Selectable from 5 to 15 characters.

To set this feature:

1. Scan the SWITCH bar code.
2. Scan the bar code representing the desired option below or on the following pages. You'll need to cover any unused bar codes on facing pages to ensure that the scanner reads only the bar code you intend to scan.

Complete the programming sequence by scanning the SWITCH bar code.



EAN-8 MINIMUM SEGMENT LENGTH = 5 CHARACTERS



EAN-8 MINIMUM SEGMENT LENGTH = 6 CHARACTERS

EAN-8 Minimum Segment Length — continued

Remember to cover any unused bar codes on this and the facing page to ensure that the scanner reads only the bar code you intend to scan.



EAN-8 MINIMUM SEGMENT LENGTH = 7 CHARACTERS



EAN-8 MINIMUM SEGMENT LENGTH = 8 CHARACTERS

EAN-8 Minimum Segment Length — continued

Remember to cover any unused bar codes on this and the facing page to ensure that the scanner reads only the bar code you intend to scan.



EAN-8 MINIMUM SEGMENT LENGTH = 9 CHARACTERS



EAN-8 MINIMUM SEGMENT LENGTH = 10 CHARACTERS

EAN-8 Minimum Segment Length — continued

Remember to cover any unused bar codes on this and the facing page to ensure that the scanner reads only the bar code you intend to scan.



EAN-8 MINIMUM SEGMENT LENGTH = 11 CHARACTERS



EAN-8 MINIMUM SEGMENT LENGTH = 12 CHARACTERS

EAN-8 Minimum Segment Length — continued

Remember to cover any unused bar codes on this and the facing page to ensure that the scanner reads only the bar code you intend to scan.



EAN-8 MINIMUM SEGMENT LENGTH = 13 CHARACTERS



EAN-8 MINIMUM SEGMENT LENGTH = 14 CHARACTERS

EAN-8 Minimum Segment Length — continued

Remember to cover any unused bar codes on this and the facing page to ensure that the scanner reads only the bar code you intend to scan.



EAN-8 MINIMUM SEGMENT LENGTH = 15 CHARACTERS

Other UPC/EAN Options

The following pages contain other selectable features for UPC/EAN symbologies:

- [Price Weight Check](#)
- [In-Store Label Minimum Reads](#)
- [Enable EAN Two Label](#)
- [EAN Two Label Minimum Reads](#)
- [Addons](#)

Price Weight Check

Enables/disables calculation and verification of price/weight check digits. Applies to all UPC-A and EAN/JAN-13 labels with eligible¹ Number System/First Character digits.

Options are:

- Disable
- 4-digit price/weight
- 5-digit price/weight
- 4-digit European price/weight
- 5-digit European price/weight

To set this feature:

1. Scan the SWITCH bar code.
2. Scan the bar code representing the desired option below or on the following pages. You'll need to cover any unused bar codes on facing pages to ensure that the scanner reads only the bar code you intend to scan.
3. Complete the programming sequence by scanning the SWITCH bar code.



PRICE WEIGHT CHECK = DISABLE

1. Price Weight Check generally applies to UPC-A labels with a Number System Digit of 2 and EAN/JAN-13 labels with a First Character of 2. There are a total of six flag digits corresponding to the six types. Checking applies depending upon which type is enabled.

Price Weight Check — continued

Remember to cover any unused bar codes on this and the facing page to ensure that the scanner reads only the bar code you intend to scan.



PRICE WEIGHT CHECK = 4-DIGIT PRICE/WEIGHT



PRICE WEIGHT CHECK = 5-DIGIT PRICE/WEIGHT

Price Weight Check — continued

Remember to cover any unused bar codes on this and the facing page to ensure that the scanner reads only the bar code you intend to scan.



PRICE WEIGHT CHECK = 4-DIGIT EUROPEAN PRICE/WEIGHT



PRICE WEIGHT CHECK = 5-DIGIT EUROPEAN PRICE/WEIGHT

In-Store Label Minimum Reads

Specifies the minimum number of consecutive times an In-Store¹ label must be decoded before it is accepted as a good read.

To set this feature:

1. Scan the SWITCH bar code.
2. Scan the bar code representing the desired option below or on the following pages. You'll need to cover any unused bar codes on facing pages to ensure that the scanner reads only the bar code you intend to scan.

Complete the programming sequence by scanning the SWITCH bar code.



IN-STORE MINIMUM READS = 1



IN-STORE MINIMUM READS = 2

1. Instore labels are defined as UPC-A labels with a number-system character of 2 or 4 as well as EAN-8 and EAN-13 labels with a Flag1 character of 2 or an EAN-13 label starting with the three characters '980'.

In-Store Label Minimum Reads — continued

Remember to cover any unused bar codes on this and the facing page to ensure that the scanner reads only the bar code you intend to scan.



IN-STORE MINIMUM READS = 3



IN-STORE MINIMUM READS = 4

Enable EAN Two Label

Enables/disables the ability of the scanner to decode EAN two-label pairs.

To set this feature:

1. Scan the SWITCH bar code.
2. Scan either the enable or disable bar code below. You'll need to cover any unused bar codes on this and the facing page to ensure that the scanner reads only the bar code you intend to scan.
3. Complete the programming sequence by scanning the SWITCH bar code.



Contact Customer Support for details about advanced programming for this feature.



EAN Two Label Combined Transmission

Enables/disables the transmitting of an EAN two label pair as one label.

To set this feature:

1. Scan the SWITCH bar code.
2. Scan either the enable or disable bar code below. You'll need to cover any unused bar codes on this and the facing page to ensure that the scanner reads only the bar code you intend to scan.
3. Complete the programming sequence by scanning the SWITCH bar code.



Contact Customer Support for details about advanced programming for this feature.



EAN TWO LABEL COMBINED TRANSMISSION = DISABLE



EAN TWO LABEL COMBINED TRANSMISSION = ENABLE

UPC/EAN Guard Insertion

Enables/Disables the ability of the scanner to insert either a missing leading or trailing guard on an otherwise complete UPC-A/EAN-13 segment it has received.

To set this feature:

1. Scan the SWITCH bar code.
2. Scan either the enable or disable bar code below. You'll need to cover any unused bar codes on this and the facing page to ensure that the scanner reads only the bar code you intend to scan.
3. Complete the programming sequence by scanning the SWITCH bar code.



UPC/EAN GUARD INSERTION = DISABLE



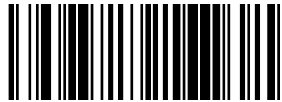
UPC/EAN GUARD INSERTION = ENABLE

UPC/EAN Stitch Exact Label Halves

When enabled, this allows the scanner the ability to stitch exact UPC-A / EAN-13 label halves with no overlapping characters.

To set this feature:

1. Scan the SWITCH bar code.
2. Scan either the enable or disable bar code below. You'll need to cover any unused bar codes on this and the facing page to ensure that the scanner reads only the bar code you intend to scan.
3. Complete the programming sequence by scanning the SWITCH bar code.



UPC/EAN STITCH EXACT LABEL HALVES = DISABLE



UPC/EAN STITCH EXACT LABEL HALVES = ENABLE

UPC/EAN Stitch Unlike Label Halves

When enabled, this allows the scanner the ability to stitch two UPC-A / EAN-13 label halves together that may contain differing characters.

To set this feature:

1. Scan the SWITCH bar code.
2. Scan either the enable or disable bar code below. You'll need to cover any unused bar codes on this and the facing page to ensure that the scanner reads only the bar code you intend to scan.
3. Complete the programming sequence by scanning the SWITCH bar code.



UPC/EAN STITCH UNLIKE LABEL HALVES = DISABLE



UPC/EAN STITCH UNLIKE LABEL HALVES = ENABLE

UPC/EAN Character Reconstruction

Enables/Disables character reconstruction on UPC/EAN labels.

To set this feature:

1. Scan the SWITCH bar code.
2. Scan either the enable or disable bar code below. You'll need to cover any unused bar codes on this and the facing page to ensure that the scanner reads only the bar code you intend to scan.
3. Complete the programming sequence by scanning the SWITCH bar code.



UPC/EAN CHARACTER RECONSTRUCTION = DISABLE



UPC/EAN CHARACTER RECONSTRUCTION = ENABLE

EAN Two Label Minimum Reads

Specifies the minimum number of consecutive times an EAN Two Label bar code must be decoded before it is accepted as a good read.

To set this feature:

1. Scan the SWITCH bar code.
2. Scan the bar code representing the desired option below or on the following pages. You'll need to cover any unused bar codes on facing pages to ensure that the scanner reads only the bar code you intend to scan.

Complete the programming sequence by scanning the SWITCH bar code.



EAN TWO LABEL MINIMUM READS = 1



EAN TWO LABEL MINIMUM READS = 2

EAN Two Label Minimum Reads — continued

Remember to cover any unused bar codes on this and the facing page to ensure that the scanner reads only the bar code you intend to scan.



EAN TWO LABEL MINIMUM READS = 3



EAN TWO LABEL MINIMUM READS = 4

UPC/EAN Correlation

This feature enables/disables character correlation for UPC/EAN.

To set this feature:

1. Scan the SWITCH bar code.
2. Scan your selection from the bar codes below. You'll need to cover any unused bar codes on this and the facing page to ensure that the scanner reads only the bar code you intend to scan.

Complete the programming sequence by scanning the SWITCH bar code.



UPC/EAN CORRELATION = DISABLE



UPC/EAN CORRELATION = ENABLE

UPC/EAN Minimum Segment Length

Specifies the minimum number of characters necessary in a UPC/EAN/JAN label segment in order for the scanner to accept a label for decoding. Selectable from 5 to 15 characters.

To set this feature:

1. Scan the SWITCH bar code.
2. Scan the bar code representing the desired option below or on the following pages. You'll need to cover any unused bar codes on facing pages to ensure that the scanner reads only the bar code you intend to scan.

Complete the programming sequence by scanning the SWITCH bar code.



UPC/EAN MINIMUM SEGMENT LENGTH = 5 CHARACTERS



UPC/EAN MINIMUM SEGMENT LENGTH = 6 CHARACTERS

UPC/EAN Minimum Segment Length — continued

Remember to cover any unused bar codes on this and the facing page to ensure that the scanner reads only the bar code you intend to scan.



UPC/EAN MINIMUM SEGMENT LENGTH = 7 CHARACTERS



UPC/EAN MINIMUM SEGMENT LENGTH = 8 CHARACTERS

UPC/EAN Minimum Segment Length — continued

Remember to cover any unused bar codes on this and the facing page to ensure that the scanner reads only the bar code you intend to scan.



UPC/EAN MINIMUM SEGMENT LENGTH = 9 CHARACTERS



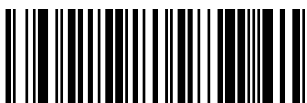
UPC/EAN MINIMUM SEGMENT LENGTH = 10 CHARACTERS

UPC/EAN Minimum Segment Length — continued

Remember to cover any unused bar codes on this and the facing page to ensure that the scanner reads only the bar code you intend to scan.



UPC/EAN MINIMUM SEGMENT LENGTH = 11 CHARACTERS



UPC/EAN MINIMUM SEGMENT LENGTH = 12 CHARACTERS

UPC/EAN Minimum Segment Length — continued

Remember to cover any unused bar codes on this and the facing page to ensure that the scanner reads only the bar code you intend to scan.



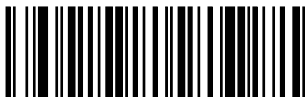
UPC/EAN MINIMUM SEGMENT LENGTH = 13 CHARACTERS



UPC/EAN MINIMUM SEGMENT LENGTH = 14 CHARACTERS

UPC/EAN Minimum Segment Length — continued

Remember to cover any unused bar codes on this and the facing page to ensure that the scanner reads only the bar code you intend to scan.



UPC/EAN MINIMUM SEGMENT LENGTH = 15 CHARACTERS

Addons

Add-ons (or supplemental characters) are commonly added to the end of UPC/EAN bar codes. The scanner will read the add-ons if they are enabled and in the field of view. Three add-on types are supported: 2-digit, 5-digit and Code 128 add-ons. Supported options are:

None. This option directs the scanner to ignore add-on portion of a UPC/EAN bar code but still read the main portion of the bar code.

2 Digits. The scanner will optionally read 2-digit add-ons with the UPC/EAN label.

5 Digits. The scanner will optionally read 5-digit add-ons with the UPC/EAN label.

Code 128 Add-on. The scanner will optionally read Code 128 add-ons with the UPC/EAN label.



Contact Customer Support for advanced programming of optional and conditional add-ons.

NOTE

To set this feature:

1. Scan the SWITCH bar code.
2. Scan the bar code representing the desired option on this and the following page. You'll need to cover any unused bar codes on facing pages to ensure that the scanner reads only the bar code you intend to scan.
3. Complete the programming sequence by scanning the SWITCH bar code.

Addons — continued

Remember to cover any unused bar codes on this and the facing page to ensure that the scanner reads only the bar code you intend to scan.



OPTIONAL 2-DIGIT ADD-ONS = DISABLE



OPTIONAL 2-DIGIT ADD-ONS = ENABLE

Addons — continued

Remember to cover any unused bar codes on this and the facing page to ensure that the scanner reads only the bar code you intend to scan.



OPTIONAL 5-DIGIT ADD-ONS = DISABLE



OPTIONAL 5-DIGIT ADD-ONS = ENABLE

Addons — continued

Remember to cover any unused bar codes on this and the facing page to ensure that the scanner reads only the bar code you intend to scan.



OPTIONAL CODE 128 ADD-ONS = DISABLE



OPTIONAL CODE 128 ADD-ONS = ENABLE

Addon Timer

When addons have been selected as optional, this feature sets the duration of time that the scanner can unsuccessfully look for an addon before proceeding to read a bar code. Timer duration is specified in 10ms increments.

To set the Addon Timer:

1. Scan the SWITCH bar code.
2. Scan the bar code, **SET ADDON TIMER DURATION** below. You'll need to cover any unused bar codes on this and the facing page to ensure that the scanner reads only the bar code you intend to scan.
3. Scan the appropriate digits from the keypad in **Appendix C** that represent the desired Addon Timer Duration. The selectable range is 1-10, which is the timeout in 10-millisecond increments. Pad all single and double digit numbers with leading zeroes to yield a three-digit entry (001-010).

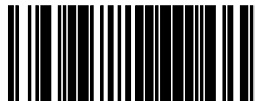
Examples:

001 = 10ms

003 = 30ms

008 = 80ms

Complete the programming sequence by scanning the SWITCH bar code.



SET ADDON TIMER DURATION

2-Digit Add-ons Minimum Reads

Specifies the minimum number of times a 2-digit addon must be read before it is marked as valid and then combined with a base label.

To set this feature:

1. Scan the SWITCH bar code.
2. Scan the bar code representing the desired option below or on the following pages. You'll need to cover any unused bar codes on facing pages to ensure that the scanner reads only the bar code you intend to scan.

Complete the programming sequence by scanning the SWITCH bar code.



2-DIGIT ADD-ONS MINIMUM READS = 1



2-DIGIT ADD-ONS MINIMUM READS = 2

2-Digit Add-ons Minimum Reads — continued

Remember to cover any unused bar codes on this and the facing page to ensure that the scanner reads only the bar code you intend to scan.



2-DIGIT ADD-ONS MINIMUM READS = 3



2-DIGIT ADD-ONS MINIMUM READS = 4

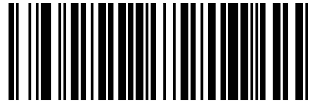
5-Digit Add-ons Minimum Reads

Specifies the minimum number of times a 5-digit addon must be read before it is marked as valid and then combined with a base label.

To set this feature:

1. Scan the SWITCH bar code.
2. Scan the bar code representing the desired option below or on the following pages. You'll need to cover any unused bar codes on facing pages to ensure that the scanner reads only the bar code you intend to scan.

Complete the programming sequence by scanning the SWITCH bar code.



5-DIGIT ADD-ONS MINIMUM READS = 1



5-DIGIT ADD-ONS MINIMUM READS = 2

5-Digit Add-ons Minimum Reads — continued

Remember to cover any unused bar codes on this and the facing page to ensure that the scanner reads only the bar code you intend to scan.



5-DIGIT ADD-ONS MINIMUM READS = 3



5-DIGIT ADD-ONS MINIMUM READS = 4

Code 128 Add-ons Minimum Reads

Specifies the minimum number of times a Code 128 add-on must be read before it is marked as valid and then combined with a base label.

To set this feature:

1. Scan the SWITCH bar code.
2. Scan the bar code representing the desired option below or on the following pages. You'll need to cover any unused bar codes on facing pages to ensure that the scanner reads only the bar code you intend to scan.

Complete the programming sequence by scanning the SWITCH bar code.



CODE 128 ADD-ONS MINIMUM READS = 1



CODE 128 ADD-ONS MINIMUM READS = 2

Code 128 Add-ons Minimum Reads — continued

Remember to cover any unused bar codes on this and the facing page to ensure that the scanner reads only the bar code you intend to scan.



CODE 128 ADD-ONS MINIMUM READS = 3



CODE 128 ADD-ONS MINIMUM READS = 4

GTIN Enable

Enables/Disables the ability to convert UPCE, UPCA, EAN8, and EAN13 labels into the GTIN 14-character format.



NOTE

If add-on information is present on the base label prior to the conversion taking place, the add-on information will be appended to the converted GTIN bar code.

To set this feature:

1. Scan the SWITCH bar code.
2. Scan either the enable or disable bar code below. You'll need to cover any unused bar codes on this and the facing page to ensure that the scanner reads only the bar code you intend to scan.
3. Complete the programming sequence by scanning the SWITCH bar code.



GTIN = DISABLE



GTIN = ENABLE

GTIN Label ID

This feature specifies a GTIN label ID to be added to bar code data when GTIN conversion is enabled.

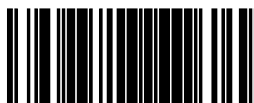


NOTE

The programming feature, **Label ID Control**, designates whether the **Label ID** is transmitted as a prefix or suffix or if **Label ID** is disabled.

To set this feature:

1. Scan the SWITCH bar code.
2. Scan the bar code, **SET GTIN LABEL ID** below. You'll need to cover any unused bar codes on this and the facing page to ensure the scanner reads only the bar code you intend to scan.
3. Scan the appropriate digits from the keypad in **Appendix C** that represent the desired Label ID characters; entered as two hex pairs. A table containing the **ASCII Character Set** and their corresponding Hex Values is available in the inside back cover of this manual. ASCII parameters must be input by scanning a pair of hexadecimal digits for each character. Thus, to set a two-character value of AB, bar codes containing the digits '4', '1', '4', and '2' must be scanned. The selectable range for this option is any hex value from 00 to FF (for each of the two characters).
4. Complete the programming sequence by scanning the SWITCH bar code.



SET GTIN LABEL ID

GTIN 2-Digit Supplemental Label ID

This feature specifies a GTIN label ID to be added to bar code data when GTIN conversion is enabled and 2-digit supplemental add-on bar code labels are converted.



NOTE

The programming feature, **Label ID Control**, designates whether the **Label ID** is transmitted as a prefix or suffix or if **Label ID** is disabled.

To set this feature:

1. Scan the SWITCH bar code.
2. Scan the bar code, **SET GTIN 2-DIGIT SUPPLEMENTAL LABEL ID** below. You'll need to cover any unused bar codes on this and the facing page to ensure the scanner reads only the bar code you intend to scan.
3. Scan the appropriate digits from the keypad in **Appendix C** that represent the desired Label ID characters; entered as two hex pairs. A table containing the **ASCII Character Set** and their corresponding Hex Values is available in the inside back cover of this manual. ASCII parameters must be input by scanning a pair of hexadecimal digits for each character. Thus, to set a two-character value of AB, bar codes containing the digits '4', '1', '4', and '2' must be scanned. The selectable range for this option is any hex value from 00 to FF (for each of the two characters).
4. Complete the programming sequence by scanning the SWITCH bar code.



SET GTIN 2-DIGIT SUPPLEMENTAL LABEL ID

GTIN 5-Digit Supplemental Label ID

This feature specifies a GTIN label ID to be added to bar code data when GTIN conversion is enabled and 5-digit supplemental add-on bar code labels are converted.

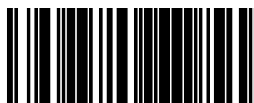


NOTE

The programming feature, **Label ID Control**, designates whether the **Label ID** is transmitted as a prefix or suffix or if **Label ID** is disabled.

To set this feature:

1. Scan the SWITCH bar code.
2. Scan the bar code, **SET GTIN 5-DIGIT SUPPLEMENTAL LABEL ID** below. You'll need to cover any unused bar codes on this and the facing page to ensure the scanner reads only the bar code you intend to scan.
3. Scan the appropriate digits from the keypad in **Appendix C** that represent the desired Label ID characters; entered as two hex pairs. A table containing the **ASCII Character Set** and their corresponding Hex Values is available in the inside back cover of this manual. ASCII parameters must be input by scanning a pair of hexadecimal digits for each character. Thus, to set a two-character value of AB, bar codes containing the digits '4', '1', '4', and '2' must be scanned. The selectable range for this option is any hex value from 00 to FF (for each of the two characters).
4. Complete the programming sequence by scanning the SWITCH bar code.



SET GTIN 5-DIGIT SUPPLEMENTAL LABEL ID

GTIN Code 128 Supplemental Label ID

This feature specifies a GTIN label ID to be added to bar code data when GTIN conversion is enabled and Code 128 supplemental add-on bar code labels are converted



NOTE

The programming feature, **Label ID Control**, designates whether the **Label ID** is transmitted as a prefix or suffix or if **Label ID** is disabled.

To set this feature:

1. Scan the SWITCH bar code.
2. Scan the bar code, [SET GTIN CODE 128 SUPPLEMENTAL LABEL ID](#) below. You'll need to cover any unused bar codes on this and the facing page to ensure the scanner reads only the bar code you intend to scan.
3. Scan the appropriate digits from the keypad in [Appendix C](#) that represent the desired Label ID characters; entered as two hex pairs. A table containing the [ASCII Character Set](#) and their corresponding Hex Values is available in the inside back cover of this manual. ASCII parameters must be input by scanning a pair of hexadecimal digits for each character. Thus, to set a two-character value of AB, bar codes containing the digits '4', '1', '4', and '2' must be scanned. The selectable range for this option is any hex value from 00 to FF (for each of the two characters).
4. Complete the programming sequence by scanning the SWITCH bar code.



SET GTIN CODE 128 SUPPLEMENTAL LABEL ID

DataBar Omnidirectional Enable

Enables/disables the ability of the scanner to decode DataBar Omnidirectional labels.



NOTE

This value-added feature is a factory-programmed option. Contact your dealer for information about upgrading your system to include this advanced capability.

To set this feature:

1. Scan the SWITCH bar code.
2. Scan either the enable or disable bar code below. You'll need to cover any unused bar codes on this and the facing page to ensure that the scanner reads only the bar code you intend to scan.
3. Complete the programming sequence by scanning the SWITCH bar code.



DataBar Omnidirectional = DISABLE



DataBar Omnidirectional = ENABLE

DataBar Omnidirectional/EAN-128 Emulation

Enables/disables the ability of DataBar Omnidirectional to be transmitted as EAN-128.

To set this feature:

1. Scan the SWITCH bar code.
2. Scan either the enable or disable bar code below. You'll need to cover any unused bar codes on this and the facing page to ensure that the scanner reads only the bar code you intend to scan.
3. Complete the programming sequence by scanning the SWITCH bar code.



DataBar Omnidirectional/EAN-128 EMULATION = DISABLE



DataBar Omnidirectional/EAN-128 EMULATION = ENABLE

DataBar Omnidirectional Label ID

This feature specifies an DataBar Omnidirectional label ID to be added to bar code data.

To set this feature:



The programming feature, Label ID Control, designates whether the Label ID is transmitted as a prefix or suffix or if Label ID is disabled.

NOTE

To set this feature:

1. Scan the SWITCH bar code.
2. Scan the bar code, [SET DataBar Omnidirectional LABEL ID](#) below. You'll need to cover any unused bar codes on this and the facing page to ensure the scanner reads only the bar code you intend to scan.
3. Scan the appropriate digits from the keypad in [Appendix C](#) that represent the desired Label ID characters; entered as two hex pairs. A table containing the [ASCII Character Set](#) and their corresponding Hex Values is available in the inside back cover of this manual. ASCII parameters must be input by scanning a pair of hexadecimal digits for each character. Thus, to set a two-character value of AB, bar codes containing the digits '4', '1', '4', and '2' must be scanned. The selectable range for this option is any hex value from 00 to FF.
4. Complete the programming sequence by scanning the SWITCH bar code.



SET DataBar Omnidirectional LABEL ID

DataBar Omnidirectional Minimum Reads

Specifies the minimum number of consecutive times an DataBar Omnidirectional label must be decoded before it is accepted as a good read.

To set this feature:

1. Scan the SWITCH bar code.
2. Scan the bar code representing the desired option below or on the following pages. You'll need to cover any unused bar codes on facing pages to ensure that the scanner reads only the bar code you intend to scan.

Complete the programming sequence by scanning the SWITCH bar code.



DataBar Omnidirectional MINIMUM READS = 1



DataBar Omnidirectional MINIMUM READS = 2

DataBar Omnidirectional Minimum Reads — continued

Remember to cover any unused bar codes on this and the facing page to ensure that the scanner reads only the bar code you intend to scan.



DataBar Omnidirectional MINIMUM READS = 3



DataBar Omnidirectional MINIMUM READS = 4

DataBar Expanded Enable

Enables/disables the ability of the scanner to decode DataBar Expanded labels.



NOTE

This value-added feature is a factory-programmed option. Contact your dealer for information about upgrading your system to include this advanced capability.

To set this feature:

1. Scan the SWITCH bar code.
2. Scan either the enable or disable bar code below. You'll need to cover any unused bar codes on this and the facing page to ensure that the scanner reads only the bar code you intend to scan.
3. Complete the programming sequence by scanning the SWITCH bar code.



DataBar Expanded = DISABLE



DataBar Expanded = ENABLE

DataBar Expanded EAN-128 Emulation

Enables/disables EAN-128 emulation for DataBar Expanded.

To set this feature:

1. Scan the SWITCH bar code.
2. Scan either the enable or disable bar code below. You'll need to cover any unused bar codes on this and the facing page to ensure that the scanner reads only the bar code you intend to scan.
3. Complete the programming sequence by scanning the SWITCH bar code.



DataBar Expanded/EAN-128 EMULATION = DISABLE



DataBar Expanded/EAN-128 EMULATION = ENABLE

DataBar Expanded Label ID

This feature specifies an DataBar Expanded label ID to be added to bar code data.



The programming feature, Label ID Control, designates whether the Label ID is transmitted as a prefix or suffix or if Label ID is disabled.

NOTE

To set this feature:

1. Scan the SWITCH bar code.
2. Scan the bar code, [SET DataBar Expanded LABEL ID](#) below. You'll need to cover any unused bar codes on this and the facing page to ensure the scanner reads only the bar code you intend to scan.
3. Scan the appropriate digits from the keypad in [Appendix C](#) that represent the desired Label ID characters; entered as two hex pairs. A table containing the [ASCII Character Set](#) and their corresponding Hex Values is available in the inside back cover of this manual. ASCII parameters must be input by scanning a pair of hexadecimal digits for each character. Thus, to set a two-character value of AB, bar codes containing the digits '4', '1', '4', and '2' must be scanned. The selectable range for this option is any hex value from 00 to FF.
4. Complete the programming sequence by scanning the SWITCH bar code.



SET DataBar Expanded LABEL ID

DataBar Expanded Length Control

This feature specifies either variable-length or fixed-length decoding for DataBar Expanded.

To set this feature:

1. Scan the SWITCH bar code.
2. Scan your selection from the bar codes below. You'll need to cover any unused bar codes on this and the facing page to ensure that the scanner reads only the bar code you intend to scan.
3. Complete the programming sequence by scanning the SWITCH bar code.



NOTE

You must now set the features [DataBar Expanded Length 1](#) and [DataBar Expanded Length 2](#).



DataBar Expanded LENGTH CONTROL = VARIABLE-LENGTH



DataBar Expanded LENGTH CONTROL = FIXED-LENGTH

DataBar Expanded Length 1

Length 1 is the minimum label length if in variable length mode, or the first fixed length if in fixed length mode (see [DataBar Expanded Length Control](#)). Length includes the barcode's check and data characters.

To set this feature:

1. Scan the SWITCH bar code.
2. Scan the bar code, [SET DataBar Expanded LENGTH 1](#) below. You'll need to cover any unused bar codes on this and the facing page to ensure that the scanner reads only the bar code you intend to scan.
3. Scan the appropriate digits from the keypad in [Appendix C](#) that represent the desired label length. The selectable range for this option is 01 to 74. Pad all single and double digit numbers with leading zeroes to yield a three-digit entry (001-074).
4. Complete the programming sequence by scanning the SWITCH bar code.



SET DataBar Expanded LENGTH 1

DataBar Expanded Length 2

Length 2 is the maximum label length if in variable length mode, or the second fixed length if in fixed length mode (see [DataBar Expanded Length Control](#)). Length includes the barcode's check and data characters.

To set this feature:

1. Scan the SWITCH bar code.
2. Scan the bar code, [SET DataBar Expanded LENGTH 2](#) below. You'll need to cover any unused bar codes on this and the facing page to ensure that the scanner reads only the bar code you intend to scan.
3. Scan the appropriate digits from the keypad in [Appendix C](#) that represent the desired label length. A setting of 000 will ignore this length (only one fixed length), otherwise, the selectable range for this option is 001 to 074. Pad all single and double digit numbers with leading zeroes to yield a three-digit entry (001-074).
4. Complete the programming sequence by scanning the SWITCH bar code.



SET DataBar Expanded LENGTH 2

DataBar Expanded Minimum Reads

Specifies the minimum number of consecutive times an DataBar Expanded label must be decoded before it is accepted as a good read.

To set this feature:

1. Scan the SWITCH bar code.
2. Scan the bar code representing the desired option below or on the following pages. You'll need to cover any unused bar codes on facing pages to ensure that the scanner reads only the bar code you intend to scan.

Complete the programming sequence by scanning the SWITCH bar code.



DataBar Expanded MINIMUM READS = 1



DataBar Expanded MINIMUM READS = 2

DataBar Expanded Minimum Reads — continued

Remember to cover any unused bar codes on this and the facing page to ensure that the scanner reads only the bar code you intend to scan.



DataBar Expanded MINIMUM READS = 3



DataBar Expanded MINIMUM READS = 4

Code 39 Enable

Enables/disables the ability of the scanner to decode Code 39 labels.

To set this feature:

1. Scan the SWITCH bar code.
2. Scan either the enable or disable bar code below. You'll need to cover any unused bar codes on this and the facing page to ensure that the scanner reads only the bar code you intend to scan.
3. Complete the programming sequence by scanning the SWITCH bar code.



Code 39 Start Stop Character Transmission

Enables/disables transmission of Code 39 start and stop characters.



This feature applies only when Code 39 Check Character Calculation is enabled.

NOTE

To set this feature:

1. Scan the SWITCH bar code.
2. Scan either the enable or disable bar code below. You'll need to cover any unused bar codes on this and the facing page to ensure that the scanner reads only the bar code you intend to scan.
3. Complete the programming sequence by scanning the SWITCH bar code.



CODE 39 START STOP CHARACTER TRANSMISSION = DISABLE



CODE 39 START STOP CHARACTER TRANSMISSION = ENABLE

Code 39 Check Character Calculation

Enables/disables calculation and verification of an optional Code 39 check character. When disabled, any check character in label is treated as a data character.



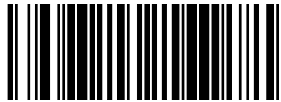
NOTE

If check calculation is disabled, the risk is increased that a misread can occur.

In particular, if you are using variable length stitching, it is important to use check character calculation to prevent misreads.

To set this feature:

1. Scan the SWITCH bar code.
2. Scan either the enable or disable bar code below. You'll need to cover any unused bar codes on this and the facing page to ensure that the scanner reads only the bar code you intend to scan.
3. Complete the programming sequence by scanning the SWITCH bar code.



CODE 39 CHECK CHARACTER CALCULATION = DISABLE



CODE 39 CHECK CHARACTER CALCULATION = ENABLE

Code 39 Check Character Transmission

Enables/disables transmission of optional Code 39 check character.

To set this feature:

1. Scan the SWITCH bar code.
2. Scan either the enable or disable bar code below. You'll need to cover any unused bar codes on this and the facing page to ensure that the scanner reads only the bar code you intend to scan.
3. Complete the programming sequence by scanning the SWITCH bar code.



CODE 39 CHECK CHARACTER TRANSMISSION = DISABLE



CODE 39 CHECK CHARACTER TRANSMISSION = ENABLE

Code 39 Full ASCII

Enables/disables the ability of the scanner to translate to Code 39 full ASCII labels.

To set this feature:

1. Scan the SWITCH bar code.
2. Scan either the enable or disable bar code below. You'll need to cover any unused bar codes on this and the facing page to ensure that the scanner reads only the bar code you intend to scan.
3. Complete the programming sequence by scanning the SWITCH bar code.



Code 39 Label ID

This feature specifies a Code 39 label ID to be added to bar code data.

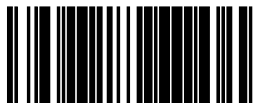


The programming feature, Label ID Control, designates whether the Label ID is transmitted as a prefix or suffix or if Label ID is disabled.

NOTE

To set this feature:

1. Scan the SWITCH bar code.
2. Scan the bar code, [SET CODE 39 LABEL ID](#) below. You'll need to cover any unused bar codes on this and the facing page to ensure the scanner reads only the bar code you intend to scan.
3. Scan the appropriate digits from the keypad in [Appendix C](#) that represent the desired Label ID characters; entered as two hex pairs. A table containing the [ASCII Character Set](#) and their corresponding Hex Values is available in the inside back cover of this manual. ASCII parameters must be input by scanning a pair of hexadecimal digits for each character. Thus, to set a two-character value of AB, bar codes containing the digits '4', '1', '4', and '2' must be scanned. The selectable range for this option is any hex value from 00 to FF.
4. Complete the programming sequence by scanning the SWITCH bar code.



SET CODE 39 LABEL ID

Code 39 Require Quiet Zones

When enabled, this feature requires that quiet zones (margins) be present for Code 39 labels. When disabled, quiet zones are optional.

To set this feature:

1. Scan the SWITCH bar code.
2. Scan either the enable or disable bar code below. You'll need to cover any unused bar codes on this and the facing page to ensure that the scanner reads only the bar code you intend to scan.
3. Complete the programming sequence by scanning the SWITCH bar code.



CODE 39 REQUIRE QUIET ZONES = DISABLE



CODE 39 REQUIRE QUIET ZONES = ENABLE

Code 39 Length Control

This feature specifies whether variable-length or fixed-length decoding will be set for Code 39.

To set this feature:

1. Scan the SWITCH bar code.
2. Scan your selection from the bar codes below. You'll need to cover any unused bar codes on this and the facing page to ensure that the scanner reads only the bar code you intend to scan.
3. Complete the programming sequence by scanning the SWITCH bar code.



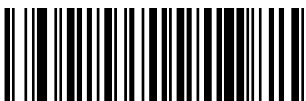
NOTE

You must now set the features [Code 39 Length 1](#) and [Code 39 Length 2](#).

When using variable length stitching, it is important to enable [Code 39 Check Character Calculation](#) to prevent misreads.



CODE 39 LENGTH CONTROL = VARIABLE-LENGTH



CODE 39 LENGTH CONTROL = FIXED-LENGTH

Code 39 Length 1

Length 1 is the minimum label length if in variable length mode, or the first fixed length if in fixed length mode (see [Code 39 Length Control](#)). Length includes the barcode's check and data characters.

To set this feature:

1. Scan the SWITCH bar code.
2. Scan the bar code, [SET CODE 39 LENGTH 1](#) below. You'll need to cover any unused bar codes on this and the facing page to ensure that the scanner reads only the bar code you intend to scan.
3. Scan the appropriate digits from the keypad in [Appendix C](#) that represent the desired label length. The selectable range for this option is 001 to 050. Pad all single and double digit numbers with leading zeroes to yield a three-digit entry (001-050).
4. Complete the programming sequence by scanning the SWITCH bar code.



SET CODE 39 LENGTH 1

Code 39 Length 2

Length 2 is the maximum label length if in variable length mode, or the second fixed length if in fixed length mode (see [Code 39 Length Control](#)). Length includes the barcode's check and data characters.

To set this feature:

1. Scan the SWITCH bar code.
2. Scan the bar code, [SET CODE 39 LENGTH 2](#) below. You'll need to cover any unused bar codes on this and the facing page to ensure that the scanner reads only the bar code you intend to scan.
3. Scan the appropriate digits from the keypad in [Appendix C](#) that represent the desired fixed label length. A setting of 000 will ignore this length (only one fixed length), otherwise, the selectable range for this option is 001 to 050. Pad all single and double digit numbers with leading zeroes to yield a three-digit entry (001-050).
4. Complete the programming sequence by scanning the SWITCH bar code.



Code 39 Correlation

This feature enables/disables character correlation for Code 39.

To set this feature:

1. Scan the SWITCH bar code.
2. Scan your selection from the bar codes below. You'll need to cover any unused bar codes on this and the facing page to ensure that the scanner reads only the bar code you intend to scan.

Complete the programming sequence by scanning the SWITCH bar code.



CODE 39 CORRELATION = DISABLE



CODE 39 CORRELATION = ENABLE

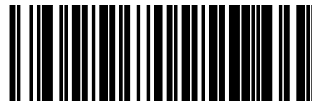
Code 39 Stitching

Enables/disables stitching for Code 39 labels. When parts of a Code 39 bar code are presented to the scanner with this feature enabled, the bar code parts will be assembled by the scanner's software, and the data will be decoded if all bar code proofing requirements are met.

To set this feature:

1. Scan the SWITCH bar code.
2. Scan your selection from the bar codes below. You'll need to cover any unused bar codes on this and the facing page to ensure that the scanner reads only the bar code you intend to scan.

Complete the programming sequence by scanning the SWITCH bar code.



CODE 39 STITCHING = DISABLE



CODE 39 STITCHING = ENABLE

Code 39 Minimum Reads

Specifies the minimum number of consecutive times a Code 39 label must be decoded before it is accepted as a good read.

To set this feature:

1. Scan the SWITCH bar code.
2. Scan the bar code representing the desired option below or on the following pages. You'll need to cover any unused bar codes on facing pages to ensure that the scanner reads only the bar code you intend to scan.

Complete the programming sequence by scanning the SWITCH bar code.



CODE 39 MINIMUM READS = 1



CODE 39 MINIMUM READS = 2

Code 39 Minimum Reads — continued

Remember to cover any unused bar codes on this and the facing page to ensure that the scanner reads only the bar code you intend to scan.



CODE 39 MINIMUM READS = 3



CODE 39 MINIMUM READS = 4

Pharmacode 39 Enable

Enables/disables the ability of the scanner to decode Italian Pharmacode 39 labels.

To set this feature:

1. Scan the SWITCH bar code.
2. Scan either the enable or disable bar code below. You'll need to cover any unused bar codes on this and the facing page to ensure that the scanner reads only the bar code you intend to scan.
3. Complete the programming sequence by scanning the SWITCH bar code.



Pharmacode 39 Start Stop Character Transmission

Enables/ disables transmission of start and stop characters for Pharmacode 39.

To set this feature:

1. Scan the SWITCH bar code.
2. Scan either the enable or disable bar code below. You'll need to cover any unused bar codes on this and the facing page to ensure that the scanner reads only the bar code you intend to scan.
3. Complete the programming sequence by scanning the SWITCH bar code.



PHARMACODE 39 START STOP CHARACTER TRANSMISSION = DISABLE



PHARMACODE 39 START STOP CHARACTER TRANSMISSION = ENABLE

Pharmacode 39 Check Character Transmission

Enables/disables transmission of Pharmacode 39 check character.

To set this feature:

1. Scan the SWITCH bar code.
2. Scan either the enable or disable bar code below. You'll need to cover any unused bar codes on this and the facing page to ensure that the scanner reads only the bar code you intend to scan.
3. Complete the programming sequence by scanning the SWITCH bar code.



PHARMACODE 39 CHECK CHARACTER TRANSMISSION = DISABLE



PHARMACODE 39 CHECK CHARACTER TRANSMISSION = ENABLE

Pharmacode 39 Label ID

This feature specifies a Pharmacode 39 label ID to be added to bar code data.

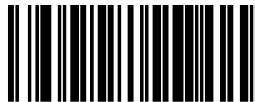


The programming feature, **Label ID Control**, designates whether the Label ID is transmitted as a prefix or suffix or if Label ID is disabled.

NOTE

To set this feature:

1. Scan the SWITCH bar code.
2. Scan the bar code, [SET PHARMACODE 39 LABEL ID](#) below. You'll need to cover any unused bar codes on this and the facing page to ensure the scanner reads only the bar code you intend to scan.
3. Scan the appropriate digits from the keypad in [Appendix C](#) that represent the desired Label ID characters; entered as two hex pairs. A table containing the [ASCII Character Set](#) and their corresponding Hex Values is available in the inside back cover of this manual. ASCII parameters must be input by scanning a pair of hexadecimal digits for each character. Thus, to set a two-character value of AB, bar codes containing the digits '4', '1', '4', and '2' must be scanned. The selectable range for this option is any hex value from 00 to FF.
4. Complete the programming sequence by scanning the SWITCH bar code.



SET PHARMACODE 39 LABEL ID

Code 128 Enable

Enables/disables¹ the ability of the scanner to decode Code 128 labels.

To set this feature:

1. Scan the SWITCH bar code.
2. Scan either the enable or disable bar code below. You'll need to cover any unused bar codes on this and the facing page to ensure that the scanner reads only the bar code you intend to scan.
3. Complete the programming sequence by scanning the SWITCH bar code.



1. Exception: The Code 128 symbology is always enabled with regard to scanning/reading the special C128 programming bar codes provided in this manual.

Code 128 Transmit Function Characters

Enables/disables transmission of Code 128 function characters 1, 2, 3, and 4.



Disabled is the recommended setting for all interfaces.

NOTE

To set this feature:

1. Scan the SWITCH bar code.
2. Scan either the enable or disable bar code below. You'll need to cover any unused bar codes on this and the facing page to ensure that the scanner reads only the bar code you intend to scan.
3. Complete the programming sequence by scanning the SWITCH bar code.



CODE 128 TRANSMIT FUNCTION CHARACTERS = DISABLE



CODE 128 TRANSMIT FUNCTION CHARACTERS = ENABLE

Convert Code 128 to Code 39

Enables/disables conversion of Code 128 labels to Code 39.

To set this feature:

1. Scan the SWITCH bar code.
2. Scan either the enable or disable bar code below. You'll need to cover any unused bar codes on this and the facing page to ensure that the scanner reads only the bar code you intend to scan.
3. Complete the programming sequence by scanning the SWITCH bar code.



CONVERT CODE 128 TO CODE 39 = DISABLE



CONVERT CODE 128 TO CODE 39 = ENABLE

Code 128 Label ID

This feature specifies a Code 128 label ID to be added to bar code data..

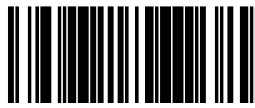


The programming feature, Label ID Control, designates whether the Label ID is transmitted as a prefix or suffix or if Label ID is disabled.

NOTE

To set this feature:

1. Scan the SWITCH bar code.
2. Scan the bar code, [SET CODE 128 LABEL ID](#) below. You'll need to cover any unused bar codes on this and the facing page to ensure the scanner reads only the bar code you intend to scan.
3. Scan the appropriate digits from the keypad in [Appendix C](#) that represent the desired Label ID characters; entered as two hex pairs. A table containing the [ASCII Character Set](#) and their corresponding Hex Values is available in the inside back cover of this manual. ASCII parameters must be input by scanning a pair of hexadecimal digits for each character. Thus, to set a two-character value of AB, bar codes containing the digits '4', '1', '4', and '2' must be scanned. The selectable range for this option is any hex value from 00 to FF.
4. Complete the programming sequence by scanning the SWITCH bar code.



SET CODE 128 LABEL ID

Code 128 Length Control

This feature specifies whether variable-length or fixed-length decoding will be set for Code 128.

To set this feature:

1. Scan the SWITCH bar code.
2. Scan your selection from the bar codes below. You'll need to cover any unused bar codes on this and the facing page to ensure that the scanner reads only the bar code you intend to scan.
3. Complete the programming sequence by scanning the SWITCH bar code.

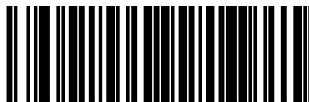


NOTE

You must now set the features **Code 128 Length 1** and **Code 128 Length 2**.



CODE 128 LENGTH CONTROL = VARIABLE-LENGTH



CODE 128 LENGTH CONTROL = FIXED-LENGTH

Code 128 Length 1

Length 1 is the minimum label length if in variable length mode, or the first fixed length if in fixed length mode (see [Code 128 Length Control](#)). Length includes the barcode's check and data characters.

To set this feature:

1. Scan the SWITCH bar code.
2. Scan the bar code, [SET CODE 128 LENGTH 1](#) below. You'll need to cover any unused bar codes on this and the facing page to ensure that the scanner reads only the bar code you intend to scan.
3. Scan the appropriate digits from the keypad in [Appendix C](#) that represent the desired label length. The selectable range for this option is 001 to 080. Pad all single and double digit numbers with leading zeroes to yield a three-digit entry (001-080).
4. Complete the programming sequence by scanning the SWITCH bar code.



Code 128 Length 2

Length 2 is the maximum label length if in variable length mode, or the second fixed length if in fixed length mode (see [Code 128 Length Control](#)). Length includes the barcode's check and data characters.

To set this feature:

1. Scan the SWITCH bar code.
2. Scan the bar code, [SET CODE 128 LENGTH 2](#) below. You'll need to cover any unused bar codes on this and the facing page to ensure that the scanner reads only the bar code you intend to scan.
3. Scan the appropriate digits from the keypad in [Appendix C](#) that represent the desired label length. A setting of 000 will ignore this length (only one fixed length), otherwise, the selectable range for this option is 001 to 080. Pad all single and double digit numbers with leading zeroes to yield a three-digit entry (001-080).
4. Complete the programming sequence by scanning the SWITCH bar code.



Code 128 Correlation

This feature enables/disables character correlation for Code 128.

To set this feature:

1. Scan the SWITCH bar code.
2. Scan your selection from the bar codes below. You'll need to cover any unused bar codes on this and the facing page to ensure that the scanner reads only the bar code you intend to scan.

Complete the programming sequence by scanning the SWITCH bar code.



CODE 128 CORRELATION = DISABLE



CODE 128 CORRELATION = ENABLE

Code 128 Stitching

Enables/disables stitching for Code 128 labels. When parts of a Code 128 bar code are presented to the scanner with this feature enabled, the bar code parts will be assembled by the scanner's software, and the data will be decoded if all bar code proofing requirements are met.

To set this feature:

1. Scan the SWITCH bar code.
2. Scan your selection from the bar codes below. You'll need to cover any unused bar codes on this and the facing page to ensure that the scanner reads only the bar code you intend to scan.

Complete the programming sequence by scanning the SWITCH bar code.



CODE 128 STITCHING = DISABLE



CODE 128 STITCHING = ENABLE

Code 128 Minimum Reads

Specifies the minimum number of consecutive times a Code 128 label must be decoded before it is accepted as a good read.

To set this feature:

1. Scan the SWITCH bar code.
2. Scan the bar code representing the desired option below or on the following pages. You'll need to cover any unused bar codes on facing pages to ensure that the scanner reads only the bar code you intend to scan.

Complete the programming sequence by scanning the SWITCH bar code.

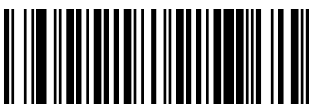


Code 128 Minimum Reads — continued

Remember to cover any unused bar codes on this and the facing page to ensure that the scanner reads only the bar code you intend to scan.



CODE 128 MINIMUM READS = 3



CODE 128 MINIMUM READS = 4

EAN-128 Enable

Enables/disables the ability of the scanner to decode EAN-128 labels. When disabled, EAN128 labels are transmitted in Code128 data format. When enabled, EAN128 labels are transmitted in EAN128 data format

To set this feature:

1. Scan the SWITCH bar code.
2. Scan either the enable or disable bar code below. You'll need to cover any unused bar codes on this and the facing page to ensure that the scanner reads only the bar code you intend to scan.
3. Complete the programming sequence by scanning the SWITCH bar code.



EAN-128 Label ID

This feature specifies an EAN-128 label ID to be added to bar code data..

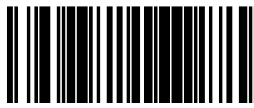


NOTE

The programming feature, Label ID Control, designates whether the Label ID is transmitted as a prefix or suffix or if Label ID is disabled.

To set this feature:

1. Scan the SWITCH bar code.
2. Scan the bar code, [SET EAN-128 LABEL ID](#) below. You'll need to cover any unused bar codes on this and the facing page to ensure the scanner reads only the bar code you intend to scan.
3. Scan the appropriate digits from the keypad in [Appendix C](#) that represent the desired Label ID characters; entered as two hex pairs. A table containing the [ASCII Character Set](#) and their corresponding Hex Values is available in the inside back cover of this manual. ASCII parameters must be input by scanning a pair of hexadecimal digits for each character. Thus, to set a two-character value of AB, bar codes containing the digits '4', '1', '4', and '2' must be scanned. The selectable range for this option is any hex value from 00 to FF.
4. Complete the programming sequence by scanning the SWITCH bar code.



SET EAN-128 LABEL ID

Interleaved 2 of 5 (I 2 of 5) Enable

Enables/disables the ability of the scanner to decode Interleaved 2 of 5 labels.

To set this feature:

1. Scan the SWITCH bar code.
2. Scan either the enable or disable bar code below. You'll need to cover any unused bar codes on this and the facing page to ensure that the scanner reads only the bar code you intend to scan.
3. Complete the programming sequence by scanning the SWITCH bar code.



I 2 of 5 Check Character Calculation

Enables/disables calculation and verification of an optional Interleaved 2 of 5 check character.



NOTE

If check character calculation is disabled, the risk is increased that a misread can occur. When disabled, any check characters in a bar code are treated as data characters.

To set this feature:

1. Scan the SWITCH bar code.
2. Scan either the enable or disable bar code below. You'll need to cover any unused bar codes on this and the facing page to ensure that the scanner reads only the bar code you intend to scan.
3. Complete the programming sequence by scanning the SWITCH bar code.



I 2 of 5 CHECK CHARACTER CALCULATION = DISABLE



I 2 of 5 CHECK CHARACTER CALCULATION = ENABLE

I 2 of 5 Check Character Transmission

Enables/disables transmission of an optional Interleaved 2 of 5 check character.



This feature applies only when I 2 of 5 Check Character Calculation is enabled.

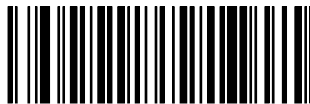
NOTE

To set this feature:

1. Scan the SWITCH bar code.
2. Scan either the enable or disable bar code below. You'll need to cover any unused bar codes on this and the facing page to ensure that the scanner reads only the bar code you intend to scan.
3. Complete the programming sequence by scanning the SWITCH bar code.



I 2 of 5 CHECK CHARACTER TRANSMISSION = DISABLE



I 2 of 5 CHECK CHARACTER TRANSMISSION = ENABLE

I 2 of 5 Label ID

This feature specifies an I 2 of 5 label ID to be added to bar code data..

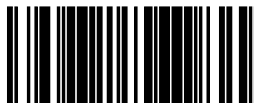


NOTE

The programming feature, Label ID Control, designates whether the Label ID is transmitted as a prefix or suffix or if Label ID is disabled.

To set this feature:

1. Scan the SWITCH bar code.
2. Scan the bar code, **SET I 2 of 5 LABEL ID** below. You'll need to cover any unused bar codes on this and the facing page to ensure the scanner reads only the bar code you intend to scan.
3. Scan the appropriate digits from the keypad in **Appendix C** that represent the desired Label ID characters; entered as two hex pairs. A table containing the **ASCII Character Set** and their corresponding Hex Values is available in the inside back cover of this manual. ASCII parameters must be input by scanning a pair of hexadecimal digits for each character. Thus, to set a two-character value of AB, bar codes containing the digits '4', '1', '4', and '2' must be scanned. The selectable range for this option is any hex value from 00 to FF.
4. Complete the programming sequence by scanning the SWITCH bar code.



SET I 2 of 5 LABEL ID

I 2 of 5 Length Control

This feature specifies whether variable-length or fixed-length decoding will be set for I 2 of 5.

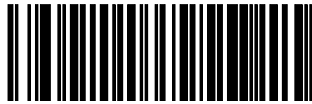
To set this feature:

1. Scan the SWITCH bar code.
2. Scan your selection from the bar codes below. You'll need to cover any unused bar codes on this and the facing page to ensure that the scanner reads only the bar code you intend to scan.
3. Complete the programming sequence by scanning the SWITCH bar code.



NOTE

You must now set the features [I 2 of 5 Length 1](#) and [I 2 of 5 Length 2](#).



I 2 OF 5 LENGTH CONTROL = VARIABLE-LENGTH



I 2 OF 5 LENGTH CONTROL = FIXED-LENGTH

I 2 of 5 Length 1

Length 1 is the minimum label length if in variable length mode, or the first fixed length if in fixed length mode (see [I 2 of 5 Length Control](#)). Length includes the barcode's check and data characters.

To set this feature:

1. Scan the SWITCH bar code.
2. Scan the bar code, [SET I 2 of 5 LENGTH 1](#) below. You'll need to cover any unused bar codes on this and the facing page to ensure that the scanner reads only the bar code you intend to scan.
3. Scan the appropriate digits from the keypad in [Appendix C](#) that represent the desired label length. The selectable range for this option is 002 to 050, even numbers only. Pad all single and double digit numbers with leading zeroes to yield a three-digit entry (002-050).
4. Complete the programming sequence by scanning the SWITCH bar code.



SET I 2 of 5 LENGTH 1

I 2 of 5 Length 2

Length 2 is the maximum label length if in variable length mode, or the second fixed length if in fixed length mode (see [I 2 of 5 Length Control](#)). Length includes the barcode's check and data characters.

To set this feature:

1. Scan the SWITCH bar code.
2. Scan the bar code, [SET I 2 of 5 LENGTH 2](#) below. You'll need to cover any unused bar codes on this and the facing page to ensure that the scanner reads only the bar code you intend to scan.
3. Scan the appropriate digits from the keypad in [Appendix C](#) that represent the desired label length. A setting of 000 will ignore this length (only one fixed length), otherwise, the selectable range for this option is 002 to 050, even numbers only. Pad all single and double digit numbers with leading zeroes to yield a three-digit entry (002-050).
4. Complete the programming sequence by scanning the SWITCH bar code.



I 2 of 5 Correlation

This feature enables/disables character correlation for I 2 of 5.

To set this feature:

1. Scan the SWITCH bar code.
2. Scan your selection from the bar codes below. You'll need to cover any unused bar codes on this and the facing page to ensure that the scanner reads only the bar code you intend to scan.

Complete the programming sequence by scanning the SWITCH bar code.



I 2 of 5 CORRELATION = DISABLE



I 2 of 5 CORRELATION = ENABLE

I 2 of 5 Stitching

Enables/disables stitching for I 2 of 5 labels. When parts of an I 2 of 5 bar code are presented to the scanner with this feature enabled, the bar code parts will be assembled by the scanner's software, and the data will be decoded if all bar code proofing requirements are met.

To set this feature:

1. Scan the SWITCH bar code.
2. Scan your selection from the bar codes below. You'll need to cover any unused bar codes on this and the facing page to ensure that the scanner reads only the bar code you intend to scan.
3. Complete the programming sequence by scanning the SWITCH bar code.



NOTE

I 2 of 5 Stitching operates using fixed lengths ONLY. I 2 of 5 Length 1 and/or I 2 of 5 Length 2 must be properly configured for stitching to work.



I 2 OF 5 STITCHING = DISABLE



I 2 OF 5 STITCHING = ENABLE

I 2 of 5 Minimum Reads

Specifies the minimum number of consecutive times an I 2 of 5 label must be decoded before it is accepted as a good read.

To set this feature:

1. Scan the SWITCH bar code.
2. Scan the bar code representing the desired option below or on the following pages. You'll need to cover any unused bar codes on facing pages to ensure that the scanner reads only the bar code you intend to scan.

Complete the programming sequence by scanning the SWITCH bar code.



I 2 of 5 Minimum Reads — continued

Remember to cover any unused bar codes on this and the facing page to ensure that the scanner reads only the bar code you intend to scan.



I 2 of 5 MINIMUM READS = 3



I 2 of 5 MINIMUM READS = 4

Standard 2 of 5 (Std 2 of 5) Enable

Enables/disables the ability of the scanner to decode Standard 2 of 5 labels.

To set this feature:

1. Scan the SWITCH bar code.
2. Scan either the enable or disable bar code below. You'll need to cover any unused bar codes on this and the facing page to ensure that the scanner reads only the bar code you intend to scan.
3. Complete the programming sequence by scanning the SWITCH bar code.



STANDARD 2 OF 5 = DISABLE



STANDARD 2 OF 5 = ENABLE

Standard 2 of 5 Check Character Calculation

Enables/disables calculation and verification of an optional Standard 2 of 5 check character.



NOTE

If check character calculation is disabled, the risk is increased that a misread can occur. When disabled, any check characters in a bar code are treated as data characters.

To set this feature:

1. Scan the SWITCH bar code.
2. Scan either the enable or disable bar code below. You'll need to cover any unused bar codes on this and the facing page to ensure that the scanner reads only the bar code you intend to scan.
3. Complete the programming sequence by scanning the SWITCH bar code.



STANDARD 2 of 5 CHECK CHARACTER CALCULATION = DISABLE



STANDARD 2 of 5 CHECK CHARACTER CALCULATION = ENABLE

Standard 2 of 5 Check Character Transmission

Enables/disables transmission of an optional Standard 2 of 5 check character.



This feature applies only when Standard 2 of 5 Check Character Calculation is enabled.

NOTE

To set this feature:

1. Scan the SWITCH bar code.
2. Scan either the enable or disable bar code below. You'll need to cover any unused bar codes on this and the facing page to ensure that the scanner reads only the bar code you intend to scan.
3. Complete the programming sequence by scanning the SWITCH bar code.



STANDARD 2 of 5 CHECK CHARACTER TRANSMISSION = DISABLE



STANDARD 2 of 5 CHECK CHARACTER TRANSMISSION = ENABLE

Standard 2 of 5 Label ID

This feature specifies a Standard 2 of 5 label ID to be added to bar code data..



The programming feature, **Label ID Control**, designates whether the Label ID is transmitted as a prefix or suffix or if Label ID is disabled.

NOTE

To set this feature:

1. Scan the SWITCH bar code.
2. Scan the bar code, [SET STANDARD 2 of 5 LABEL ID](#) below. You'll need to cover any unused bar codes on this and the facing page to ensure the scanner reads only the bar code you intend to scan.
3. Scan the appropriate digits from the keypad in [Appendix C](#) that represent the desired Label ID characters; entered as two hex pairs. A table containing the [ASCII Character Set](#) and their corresponding Hex Values is available in the inside back cover of this manual. ASCII parameters must be input by scanning a pair of hexadecimal digits for each character. Thus, to set a two-character value of AB, bar codes containing the digits '4', '1', '4', and '2' must be scanned. The selectable range for this option is any hex value from 00 to FF.
4. Complete the programming sequence by scanning the SWITCH bar code.



SET STANDARD 2 of 5 LABEL ID

Standard 2 of 5 Length Control

This feature specifies whether variable-length or fixed-length decoding will be set for Standard 2 of 5.

To set this feature:

1. Scan the SWITCH bar code.
2. Scan your selection from the bar codes below. You'll need to cover any unused bar codes on this and the facing page to ensure that the scanner reads only the bar code you intend to scan.
3. Complete the programming sequence by scanning the SWITCH bar code.



NOTE

You must now set Standard 2 of 5 Length 1 and Standard 2 of 5 Length 2.



STANDARD 2 OF 5 LENGTH CONTROL = VARIABLE-LENGTH



STANDARD 2 OF 5 LENGTH CONTROL = FIXED-LENGTH

Standard 2 of 5 Length 1

Length 1 is the minimum label length if in variable length mode, or the first fixed length if in fixed length mode (see [Standard 2 of 5 Length Control](#)). Length includes the barcode's check and data characters.

To set this feature:

1. Scan the SWITCH bar code.
2. Scan the bar code, [SET STANDARD 2 OF 5 LENGTH 1](#) below. You'll need to cover any unused bar codes on this and the facing page to ensure that the scanner reads only the bar code you intend to scan.
3. Scan the appropriate digits from the keypad in [Appendix C](#) that represent the desired label length. The selectable range for this option is 001 to 050. Pad all single and double digit numbers with leading zeroes to yield a three-digit entry (001-050).
4. Complete the programming sequence by scanning the SWITCH bar code.



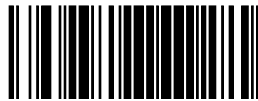
SET STANDARD 2 OF 5 LENGTH 1

Standard 2 of 5 Length 2

Length 2 is the maximum label length if in variable length mode, or the second fixed length if in fixed length mode (see [Standard 2 of 5 Length Control](#)). Length includes the barcode's check and data characters.

To set this feature:

1. Scan the SWITCH bar code.
2. Scan the bar code, [SET STANDARD 2 OF 5 LENGTH 2](#) below. You'll need to cover any unused bar codes on this and the facing page to ensure that the scanner reads only the bar code you intend to scan.
3. Scan the appropriate digits from the keypad in [Appendix C](#) that represent the desired label length. A setting of 000 will ignore this length (only one fixed length), otherwise, the selectable range for this option is 001 to 050. Pad all single and double digit numbers with leading zeroes to yield a three-digit entry (001-050).
4. Complete the programming sequence by scanning the SWITCH bar code.



SET STANDARD 2 OF 5 LENGTH 2

Standard 2 of 5 Correlation

This feature enables/disables character correlation for Standard 2 of 5.

To set this feature:

1. Scan the SWITCH bar code.
2. Scan your selection from the bar codes below. You'll need to cover any unused bar codes on this and the facing page to ensure that the scanner reads only the bar code you intend to scan.

Complete the programming sequence by scanning the SWITCH bar code.



STANDARD 2 of 5 CORRELATION = DISABLE



STANDARD 2 of 5 CORRELATION = ENABLE

Standard 2 of 5 Stitching

Enables/disables stitching for Standard 2 of 5 labels. When parts of a Standard 2 of 5 bar code are presented to the scanner with this feature enabled, the bar code parts will be assembled by the scanner's software, and the data will be decoded if all bar code proofing requirements are met.

To set this feature:

1. Scan the SWITCH bar code.
2. Scan your selection from the bar codes below. You'll need to cover any unused bar codes on this and the facing page to ensure that the scanner reads only the bar code you intend to scan.
3. Complete the programming sequence by scanning the SWITCH bar code.



NOTE

Standard 2 of 5 Stitching operates using fixed lengths ONLY. Standard 2 of 5 Length 1 and/or Standard 2 of 5 Length 2 must be properly configured for stitching to work.



I 2 OF 5 STITCHING = DISABLE



I 2 OF 5 STITCHING = ENABLE

Standard 2 of 5 Minimum Reads

Specifies the minimum number of consecutive times a Standard 2 of 5 label must be decoded before it is accepted as a good read.

To set this feature:

1. Scan the SWITCH bar code.
2. Scan the bar code representing the desired option below or on the following pages. You'll need to cover any unused bar codes on facing pages to ensure that the scanner reads only the bar code you intend to scan.

Complete the programming sequence by scanning the SWITCH bar code.



STANDARD 2 of 5 MINIMUM READS = 1



STANDARD 2 of 5 MINIMUM READS = 2

Standard 2 of 5 Minimum Reads — continued

Remember to cover any unused bar codes on this and the facing page to ensure that the scanner reads only the bar code you intend to scan.



STANDARD 2 of 5 MINIMUM READS = 3



STANDARD 2 of 5 MINIMUM READS = 4

Codabar Enable

Enables/disables the ability of the scanner to decode Codabar labels.

To set this feature:

1. Scan the SWITCH bar code.
2. Scan either the enable or disable bar code below. You'll need to cover any unused bar codes on this and the facing page to ensure that the scanner reads only the bar code you intend to scan.
3. Complete the programming sequence by scanning the SWITCH bar code.

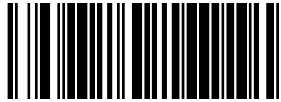


Codabar Start Stop Character Transmission

Enables/disables transmission of Codabar start and stop characters.

To set this feature:

1. Scan the SWITCH bar code.
2. Scan either the enable or disable bar code below. You'll need to cover any unused bar codes on this and the facing page to ensure that the scanner reads only the bar code you intend to scan.
3. Complete the programming sequence by scanning the SWITCH bar code.



CODABAR START STOP CHARACTER TRANSMISSION = DISABLE



CODABAR START STOP CHARACTER TRANSMISSION = ENABLE

Codabar Start Stop Character Set

This feature selects the format of transmitted Codabar start/stop characters.

Options are:

- ABCD/TN* E
- ABCD/ABCD
- abcd/tn* e
- abcd/abcd

To set this feature:

1. Scan the SWITCH bar code.
2. Scan the bar code below or from the following page representing the desired option. You'll need to cover any unused bar codes and facing pages to ensure that the scanner reads only the bar code you intend to scan.
3. Complete the programming sequence by scanning the SWITCH bar code.



CODABAR START STOP CHARACTER = ABCD/TN* E



CODABAR START STOP CHARACTER = ABCD/ABCD

Codabar Start Stop Character Set — continued

Remember to cover any unused bar codes on this and the facing page to ensure that the scanner reads only the bar code you intend to scan.



CODABAR START STOP CHARACTER = abcd/tn* e



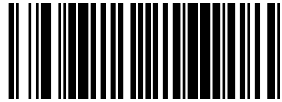
CODABAR START STOP CHARACTER = abcd/abcd

Codabar Start Stop Character Match

Enables/disables the requirement that start and stop characters match.

To set this feature:

1. Scan the SWITCH bar code.
2. Scan either the enable or disable bar code below. You'll need to cover any unused bar codes on this and the facing page to ensure that the scanner reads only the bar code you intend to scan.
3. Complete the programming sequence by scanning the SWITCH bar code.



CODABAR START STOP CHARACTER MATCH = DISABLE



CODABAR START STOP CHARACTER MATCH = ENABLE

Codabar Check Character Calculation

Enables/disables calculation and verification of an optional Codabar check character.



If check character calculation is disabled, the risk is increased that a misread can occur. When disabled, any check characters in a bar code are treated as data characters.

NOTE

To set this feature:

1. Scan the SWITCH bar code.
2. Scan either the enable or disable bar code below. You'll need to cover any unused bar codes on this and the facing page to ensure that the scanner reads only the bar code you intend to scan.
3. Complete the programming sequence by scanning the SWITCH bar code.



CODABAR CHECK CHARACTER CALCULATION = DISABLE



CODABAR CHECK CHARACTER CALCULATION = ENABLE

Codabar Check Character Transmission

Enables/disables transmission of an optional Codabar check character.



Applies only when Codabar Check Character Calculation is enabled.

NOTE

To set this feature:

1. Scan the SWITCH bar code.
2. Scan either the enable or disable bar code below. You'll need to cover any unused bar codes on this and the facing page to ensure that the scanner reads only the bar code you intend to scan.
3. Complete the programming sequence by scanning the SWITCH bar code.



CODABAR CHECK CHARACTER TRANSMISSION = DISABLE



CODABAR CHECK CHARACTER TRANSMISSION = ENABLE

Codabar Label ID

This feature specifies a Codabar label ID to be added to bar code data.

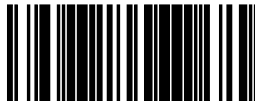


The programming feature, Label ID Control, designates whether the Label ID is transmitted as a prefix or suffix or if Label ID is disabled.

NOTE

To set this feature:

1. Scan the SWITCH bar code.
2. Scan the bar code, [SET CODABAR LABEL ID](#) below. You'll need to cover any unused bar codes on this and the facing page to ensure the scanner reads only the bar code you intend to scan.
3. Scan the appropriate digits from the keypad in [Appendix C](#) that represent the desired Label ID characters; entered as two hex pairs. A table containing the [ASCII Character Set](#) and their corresponding Hex Values is available in the inside back cover of this manual. ASCII parameters must be input by scanning a pair of hexadecimal digits for each character. Thus, to set a two-character value of AB, bar codes containing the digits '4', '1', '4', and '2' must be scanned. The selectable range for this option is any hex value from 00 to FF.
4. Complete the programming sequence by scanning the SWITCH bar code.



SET CODABAR LABEL ID

Codabar Require Quiet Zones

When enabled, this feature requires that quiet zones (margins) be present for Codabar labels. When disabled, quiet zones are optional.

To set this feature:

1. Scan the SWITCH bar code.
2. Scan either the enable or disable bar code below. You'll need to cover any unused bar codes on this and the facing page to ensure that the scanner reads only the bar code you intend to scan.
3. Complete the programming sequence by scanning the SWITCH bar code.



CODABAR REQUIRE QUIET ZONES = DISABLE



CODABAR REQUIRE QUIET ZONES = ENABLE

Codabar Length Control

This feature specifies whether variable-length or fixed-length decoding will be set for Codabar.

To set this feature:

1. Scan the SWITCH bar code.
2. Scan your selection from the bar codes below. You'll need to cover any unused bar codes on this and the facing page to ensure that the scanner reads only the bar code you intend to scan.
3. Complete the programming sequence by scanning the SWITCH bar code.



NOTE

You must now set the features [Codabar Length 1](#) and [Codabar Length 2](#).



CODABAR LENGTH CONTROL = VARIABLE-LENGTH



CODABAR LENGTH CONTROL = FIXED-LENGTH

Codabar Length 1

Length 1 is the minimum label length if in variable length mode, or the first fixed length if in fixed length mode (see [Codabar Length Control](#)). Length includes the barcode's check and data characters.

To set this feature:

1. Scan the SWITCH bar code.
2. Scan the bar code, [SET CODABAR LENGTH 1](#) below. You'll need to cover any unused bar codes on this and the facing page to ensure that the scanner reads only the bar code you intend to scan.
3. Scan the appropriate digits from the keypad in [Appendix C](#) that represent the desired label length. The selectable range for this option is 003 to 050. Pad all single and double digit numbers with leading zeroes to yield a three-digit entry (003-050).
4. Complete the programming sequence by scanning the SWITCH bar code.



Codabar Length 2

Length 2 is the maximum label length if in variable length mode, or the second fixed length if in fixed length mode (see [Codabar Length Control](#)). Length includes the barcode's check and data characters.

To set this feature:

1. Scan the SWITCH bar code.
2. Scan the bar code, [SET STANDARD 2 OF 5 LENGTH 2](#) below. You'll need to cover any unused bar codes on this and the facing page to ensure that the scanner reads only the bar code you intend to scan.
3. Scan the appropriate digits from the keypad in [Appendix C](#) that represent the desired label length. A setting of 000 will ignore this length (only one fixed length), otherwise, the selectable range for this option is 003 to 050. Pad all single and double digit numbers with leading zeroes to yield a three-digit entry (003-050).
4. Complete the programming sequence by scanning the SWITCH bar code.



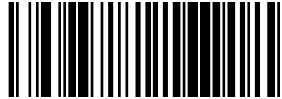
Codabar Correlation

This feature enables/disables character correlation for Codabar.

To set this feature:

1. Scan the SWITCH bar code.
2. Scan your selection from the bar codes below. You'll need to cover any unused bar codes on this and the facing page to ensure that the scanner reads only the bar code you intend to scan.

Complete the programming sequence by scanning the SWITCH bar code.



CODABAR CORRELATION = DISABLE



CODABAR CORRELATION = ENABLE

Codabar Stitching

Enables/disables stitching for Codabar labels. When parts of a Codabar bar code are presented to the scanner with this feature enabled, the bar code parts will be assembled by the scanner's software, and the data will be decoded if all bar code proofing requirements are met.

To set this feature:

1. Scan the SWITCH bar code.
2. Scan your selection from the bar codes below. You'll need to cover any unused bar codes on this and the facing page to ensure that the scanner reads only the bar code you intend to scan.

Complete the programming sequence by scanning the SWITCH bar code.



NOTE

Codabar Stitching operates using fixed lengths ONLY. **Codabar Length 1** and/or **Codabar Length 2** must be properly configured for stitching to work.



CODABAR STITCHING = DISABLE



CODABAR STITCHING = ENABLE

Codabar Minimum Reads

Specifies the minimum number of consecutive times a Codabar label must be decoded before it is accepted as a good read.

To set this feature:

1. Scan the SWITCH bar code.
2. Scan the bar code representing the desired option below or on the following pages. You'll need to cover any unused bar codes on facing pages to ensure that the scanner reads only the bar code you intend to scan.

Complete the programming sequence by scanning the SWITCH bar code.



Codabar Minimum Reads — continued

Remember to cover any unused bar codes on this and the facing page to ensure that the scanner reads only the bar code you intend to scan.



CODABAR MINIMUM READS = 3



CODABAR MINIMUM READS = 4

Code 93 Enable

Enables/disables the ability of the scanner to decode Code 93 labels.

To set this feature:

1. Scan the SWITCH bar code.
2. Scan either the enable or disable bar code below. You'll need to cover any unused bar codes on this and the facing page to ensure that the scanner reads only the bar code you intend to scan.
3. Complete the programming sequence by scanning the SWITCH bar code.



Code 93 Label ID

This feature specifies a Code 93 label ID to be added to bar code data..

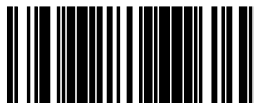


NOTE

The programming feature, **Label ID Control**, designates whether the Label ID is transmitted as a prefix or suffix or if Label ID is disabled.

To set this feature:

1. Scan the SWITCH bar code.
2. Scan the bar code, **SET CODE 93 LABEL ID** below. You'll need to cover any unused bar codes on this and the facing page to ensure the scanner reads only the bar code you intend to scan.
3. Scan the appropriate digits from the keypad in **Appendix C** that represent the desired Label ID characters; entered as two hex pairs. A table containing the **ASCII Character Set** and their corresponding Hex Values is available in the inside back cover of this manual. ASCII parameters must be input by scanning a pair of hexadecimal digits for each character. Thus, to set a two-character value of AB, bar codes containing the digits '4', '1', '4', and '2' must be scanned. The selectable range for this option is any hex value from 00 to FF.
4. Complete the programming sequence by scanning the SWITCH bar code.



SET CODE 93 LABEL ID

Code 93 Length Control

This feature specifies whether variable-length or fixed-length decoding will be set for Code 93.

To set this feature:

1. Scan the SWITCH bar code.
2. Scan your selection from the bar codes below. You'll need to cover any unused bar codes on this and the facing page to ensure that the scanner reads only the bar code you intend to scan.
3. Complete the programming sequence by scanning the SWITCH bar code.



NOTE

You must now set the features [Code 93 Length 1](#) and [Code 93 Length 2](#).



CODE 93 LENGTH CONTROL = VARIABLE-LENGTH



CODE 93 LENGTH CONTROL = FIXED-LENGTH

Code 93 Length 1

Length 1 is the minimum label length if in variable length mode, or the first fixed length if in fixed length mode (see [Code 93 Length Control](#)). Length includes the barcode's check and data characters.

To set this feature:

1. Scan the SWITCH bar code.
2. Scan the bar code, [SET CODE 93 LENGTH 1](#) below. You'll need to cover any unused bar codes on this and the facing page to ensure that the scanner reads only the bar code you intend to scan.
3. Scan the appropriate digits from the keypad in [Appendix C](#) that represent the desired label length. The selectable range for this option is 001 to 050. Pad all single and double digit numbers with leading zeroes to yield a three-digit entry (001-050).
4. Complete the programming sequence by scanning the SWITCH bar code.



SET CODE 93 LENGTH 1

Code 93 Length 2

Length 2 is the maximum label length if in variable length mode, or the second fixed length if in fixed length mode (see [Code 93 Length Control](#)). Length includes the barcode's check and data characters.

To set this feature:

1. Scan the SWITCH bar code.
2. Scan the bar code, [SET CODE 93 LENGTH 2](#) below. You'll need to cover any unused bar codes on this and the facing page to ensure that the scanner reads only the bar code you intend to scan.
3. Scan the appropriate digits from the keypad in [Appendix C](#) that represent the desired label length. A setting of 000 will ignore this length (only one fixed length), otherwise, the selectable range for this option is 001 to 050. Pad all single and double digit numbers with leading zeroes to yield a three-digit entry (001-050).
4. Complete the programming sequence by scanning the SWITCH bar code.



Code 93 Correlation

This feature enables/disables character correlation for Code 93.

To set this feature:

1. Scan the SWITCH bar code.
2. Scan your selection from the bar codes below. You'll need to cover any unused bar codes on this and the facing page to ensure that the scanner reads only the bar code you intend to scan.

Complete the programming sequence by scanning the SWITCH bar code.



CODE 93 CORRELATION = DISABLE



CODE 93 CORRELATION = ENABLE

Code 93 Stitching

Enables/disables stitching for Code 93 labels. When parts of a Code 93 bar code are presented to the scanner with this feature enabled, the bar code parts will be assembled by the scanner's software, and the data will be decoded if all bar code proofing requirements are met.

To set this feature:

1. Scan the SWITCH bar code.
2. Scan your selection from the bar codes below. You'll need to cover any unused bar codes on this and the facing page to ensure that the scanner reads only the bar code you intend to scan.

Complete the programming sequence by scanning the SWITCH bar code.



CODE 93 STITCHING = DISABLE



CODE 93 STITCHING = ENABLE

Code 93 Minimum Reads

Specifies the minimum number of consecutive times a Code 93 label must be decoded before it is accepted as a good read.

To set this feature:

1. Scan the SWITCH bar code.
2. Scan the bar code representing the desired option below or on the following pages. You'll need to cover any unused bar codes on facing pages to ensure that the scanner reads only the bar code you intend to scan.

Complete the programming sequence by scanning the SWITCH bar code.

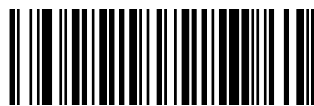


Code 93 Minimum Reads — continued

Remember to cover any unused bar codes on this and the facing page to ensure that the scanner reads only the bar code you intend to scan.



CODE 93 MINIMUM READS = 3



CODE 93 MINIMUM READS = 4

MSI/Plessey Enable

Enables/disables the ability of the scanner to decode MSI/Plessey labels.

To set this feature:

1. Scan the SWITCH bar code.
2. Scan either the enable or disable bar code below. You'll need to cover any unused bar codes on this and the facing page to ensure that the scanner reads only the bar code you intend to scan.
3. Complete the programming sequence by scanning the SWITCH bar code.



MSI/Plessey Check Character Calculation

Enables/disables calculation and verification of optional MSI/Plessey check characters.



NOTE

If check character calculation is disabled, the risk is increased that a misread can occur. When disabled, any check characters in a bar code are treated as data characters.

To set this feature:

1. Scan the SWITCH bar code.
2. Scan either the enable or disable bar code below. You'll need to cover any unused bar codes on this and the facing page to ensure that the scanner reads only the bar code you intend to scan.
3. Complete the programming sequence by scanning the SWITCH bar code.



MSI/PLESSEY CHECK CHARACTER CALCULATION = DISABLE



MSI/PLESSEY CHECK CHARACTER CALCULATION = ENABLE

MSI/Plessey Number of Check Characters

Specifies number of MSI/Plessey check characters to be calculated and verified.



Check characters are always modulus 10.

NOTE

To set this feature:

1. Scan the SWITCH bar code.
2. Scan the bar code below representing the desired number of MSI/Plessey check characters to be calculated and verified. You'll need to cover any unused bar codes on this and the facing page to ensure that the scanner reads only the bar code you intend to scan.
3. Complete the programming sequence by scanning the SWITCH bar code.



MSI/PLESSEY NUMBER OF CHECK CHARACTERS = 1



MSI/PLESSEY NUMBER OF CHECK CHARACTERS = 2

MSI/Plessey Check Character Transmission

Enables/disables transmission of optional MSI/Plessey check characters.



This feature applies only when MSI/Plessey Check Character Calculation is enabled.

NOTE

To set this feature:

1. Scan the SWITCH bar code.
2. Scan either the enable or disable bar code below. You'll need to cover any unused bar codes on this and the facing page to ensure that the scanner reads only the bar code you intend to scan.
3. Complete the programming sequence by scanning the SWITCH bar code.



MSI/PLESSEY CHECK CHARACTER TRANSMISSION = DISABLE



MSI/PLESSEY CHECK CHARACTER TRANSMISSION = ENABLE

MSI/Plessey Label ID

This feature specifies an MSI/Plessey label ID to be added to bar code data.



The programming feature, Label ID Control, designates whether the Label ID is transmitted as a prefix or suffix or if Label ID is disabled.

NOTE

To set this feature:

1. Scan the SWITCH bar code.
2. Scan the bar code, [SET MSI/PLESSEY LABEL ID](#) below. You'll need to cover any unused bar codes on this and the facing page to ensure the scanner reads only the bar code you intend to scan.
3. Scan the appropriate digits from the keypad in [Appendix C](#) that represent the desired Label ID characters; entered as two hex pairs. A table containing the [ASCII Character Set](#) and their corresponding Hex Values is available in the inside back cover of this manual. ASCII parameters must be input by scanning a pair of hexadecimal digits for each character. Thus, to set a two-character value of AB, bar codes containing the digits '4', '1', '4', and '2' must be scanned. The selectable range for this option is any hex value from 00 to FF.
4. Complete the programming sequence by scanning the SWITCH bar code.



SET MSI/PLESSEY LABEL ID

MSI/Plessey Length Control

This feature specifies whether variable-length or fixed-length decoding will be set for MSI/Plessey.

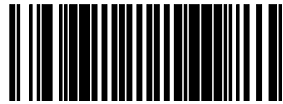
To set this feature:

1. Scan the SWITCH bar code.
2. Scan your selection from the bar codes below. You'll need to cover any unused bar codes on this and the facing page to ensure that the scanner reads only the bar code you intend to scan.
3. Complete the programming sequence by scanning the SWITCH bar code.



NOTE

You must now set the features [MSI/Plessey Length 1](#) and [MSI/Plessey Length 2](#).



MSI/PLESSEY LENGTH CONTROL = VARIABLE-LENGTH



MSI/PLESSEY LENGTH CONTROL = FIXED-LENGTH

MSI/Plessey Length 1

Length 1 is the minimum label length if in variable length mode, or the first fixed length if in fixed length mode (see [MSI/Plessey Length Control](#)). Length includes the barcode's check and data characters.

To set this feature:

1. Scan the SWITCH bar code.
2. Scan the bar code, [SET MSI/PLESSEY LENGTH 1](#) below. You'll need to cover any unused bar codes on this and the facing page to ensure that the scanner reads only the bar code you intend to scan.
3. Scan the appropriate digits from the keypad in [Appendix C](#) that represent the desired label length. The selectable range for this option is 004 to 016. Pad all single and double digit numbers with leading zeroes to yield a three-digit entry (004-016).
4. Complete the programming sequence by scanning the SWITCH bar code.



SET MSI/PLESSEY LENGTH 1

MSI/Plessey Length 2

Length 2 is the maximum label length if in variable length mode, or the second fixed length if in fixed length mode (see [Code 93 Length Control](#)). Length includes the barcode's check and data characters.

To set this feature:

1. Scan the SWITCH bar code.
2. Scan the bar code, [SET CODE 93 LENGTH 2](#) below. You'll need to cover any unused bar codes on this and the facing page to ensure that the scanner reads only the bar code you intend to scan.
3. Scan the appropriate digits from the keypad in [Appendix C](#) that represent the desired label length. A setting of 000 will ignore this length (only one fixed length), otherwise, the selectable range for this option is 004 to 016. Pad all single and double digit numbers with leading zeroes to yield a three-digit entry (004-016).
4. Complete the programming sequence by scanning the SWITCH bar code.



SET MSI/PLESSEY LENGTH 2

MSI/Plessey Correlation

This feature enables/disables character correlation for MSI/Plessey.

To set this feature:

1. Scan the SWITCH bar code.
2. Scan your selection from the bar codes below. You'll need to cover any unused bar codes on this and the facing page to ensure that the scanner reads only the bar code you intend to scan.

Complete the programming sequence by scanning the SWITCH bar code.



MSI/PLESSEY CORRELATION = DISABLE



MSI/PLESSEY CORRELATION = ENABLE

MSI/Plessey Stitching

Enables/disables stitching for MSI/Plessey labels. When parts of an MSI/Plessey bar code are presented to the scanner with this feature enabled, the bar code parts will be assembled by the scanner's software, and the data will be decoded if all bar code proofing requirements are met.

To set this feature:

1. Scan the SWITCH bar code.
2. Scan your selection from the bar codes below. You'll need to cover any unused bar codes on this and the facing page to ensure that the scanner reads only the bar code you intend to scan.
3. Complete the programming sequence by scanning the SWITCH bar code.



NOTE

MSI/Plessey Stitching operates using fixed lengths ONLY. MSI/Plessey Length 1 and/or MSI/Plessey Length 2 must be properly configured for stitching to work.



MSI/PLESSEY STITCHING = DISABLE



MSI/PLESSEY STITCHING = ENABLE

MSI/Plessey Minimum Reads

Specifies the minimum number of consecutive times an MSI/Plessey label must be decoded before it is accepted as a good read.

To set this feature:

1. Scan the SWITCH bar code.
2. Scan the bar code representing the desired option below or on the following pages. You'll need to cover any unused bar codes on facing pages to ensure that the scanner reads only the bar code you intend to scan.

Complete the programming sequence by scanning the SWITCH bar code.



MSI/PLESSEY MINIMUM READS = 1



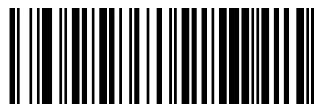
MSI/PLESSEY MINIMUM READS = 2

MSI/Plessey Minimum Reads — continued

Remember to cover any unused bar codes on this and the facing page to ensure that the scanner reads only the bar code you intend to scan.



MSI/PLESSEY MINIMUM READS = 3



MSI/PLESSEY MINIMUM READS = 4

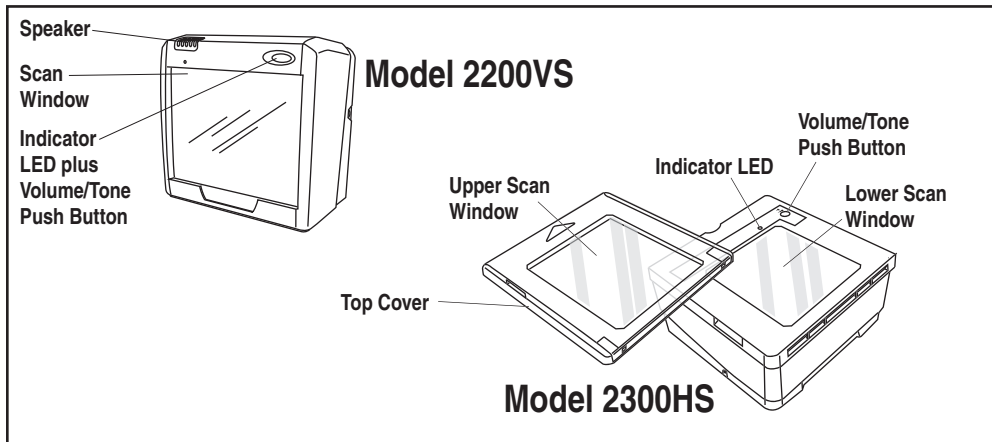
NOTES

Appendix A

LED/Beeper Indications & Controls

Figure A-1 shows the operator's controls and indicators for both models. The descriptions following identify the use or function of each component.

Figure A-1. Scanner Controls and Indicators



Volume/Tone Push Button

The Volume/Tone Push Button also performs multiple functions depending upon the duration of time it is pressed:



NOTE

Volume changes made using the Volume/Tone Push Button are lost when the scanner is powered-down and are reset to the configured setting. If you wish to permanently change the volume, use the special programming labels in the Product Reference Guide.

Table A-1. Volume/Tone Push Button Functions






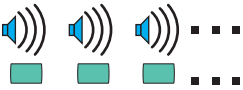

PRESS DURATION	FUNCTION	COMMENT
Momentary (when scanner is asleep)	Wakes scanner from Sleep Mode	Alternatively, the scanner can be awakened by: - Moving an object through the scan zone. - Scanning with an attached auxiliary scanner.
Momentary (when scanner is awake)	Increments volume	Press the push button momentarily to increase speaker volume. When the loudest volume is reached, a repeated press of the push button cycles volume back to the lowest setting, then volume increases on subsequent press(es). Four volume levels are available.
Hold, then release when the beeper sounds	Increments tone	Press the push button for approximately 2 seconds, then release. Each time this is done, the beeper will sound at one of three tones. Stop when the desired tone (high, medium or low) is sounded.
4 Seconds	Scanner Diagnostics Mode ^a	This mode allows system support personnel to troubleshoot problems with the scanner and is used to determine if it can read bar codes. Press the button for eight seconds or cycle power to exit Scanner Diagnostics Mode and reset the scanner.
8 Seconds	Resets Scanner ^b	Only system support personnel should perform a reset.

- a. By standard default, this function is normally disabled to prevent accidental activation by users.
- b. Users should not perform scanner resets except under the direction of trained systems support personnel.

Green LED Indicator

The green LED indicates scanner status as shown in the table below.

Table A-2. Green LED Indications

LED INDICATION	DURATION	COMMENT
Scanner Active ^a (Normal Mode)	Scanner (Green) LED on steady and dim 	The scanner is ready for operation. Scanning is immediately available.
Good Read Indication ^a	Scanner (Green) LED - bright flash 	Indicates a bar code has been read and decoded.
Program Mode Indication	Scanner (Green) LED - Continuous flashing 	Indicates the scanner is in Label Programming Mode. Cycle power to exit Programming Mode.
Sleep Mode Indication	Scanner (Green) LED flashes slowly 	The scanner motor and/or laser have automatically switched off and the unit has entered Sleep Mode due to extended inactivity.
Host Disabled	Scanner (Green) LED 1-second off, 1/10-second on 	Host has disabled scanning.
Field Replaceable Unit (FRU) Warning (Error Mode)	Audible low tone 1 second. LED flashes continuously. 	Serves notice that a fatal FRU failure has been detected. Call systems support for service.
FRU Indication	Scanner (Green) LED flashes a coded sequence in concert with the speaker. 	Occurs ONLY upon Volume/Tone button push following a FRU warning. Enables service technicians to identify FRU failures.

a. Certain functions of the LED is selectable to be enabled or disabled. Your scanner may not be programmed to display all indications.

NOTES

Appendix B

Cable Information

Introduction

The following pages contain pinout information, enabling you to create an auxiliary port cable for use in interconnecting the scanner to an external handheld scanner.

General Specifications

Wire Requirements

- Cable length should not exceed 15 feet.
- Wire gauge = Standard for RJ-45 connectors (28-26 AWG).
- If run exceeds 15 feet, we recommend 26 AWG wire size.

Auxiliary Port

External Handheld Input

Connector Hardware

RJ45, 10 Position

Cable Pinout

Table B-1

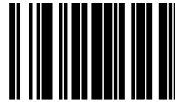
PIN #	FUNCTION	DESCRIPTION
1	DTR	Data Terminal Ready
2	CTS in	Clear To Send (input)
3	N/C	No Connection - Reserved
4	RTS out	Request To Send (output)
5	RxD in	Receive Data (Input)
6	TxD out	Transmit Data (output)
7	~EAS_GOOD READ	Special use Good Read
8	+5V out (500mA max)	+5V out
9	GND	Signal Ground
10	SPKR OUT	Speaker Out

Appendix C

Keypad

Use the bar codes in this section to enter numbers and characters as you would select digits/characters from a keypad.

Scan your selection from the bar codes below. You'll need to cover any unused bar codes on this and the facing page to ensure that the scanner reads only the bar code you intend to scan.



0



1

Use the bar codes in this section to enter numbers and characters as you would select digits/characters from a keypad.

Scan your selection from the bar codes below. You'll need to cover any unused bar codes on this and the facing page to ensure that the scanner reads only the bar code you intend to scan.



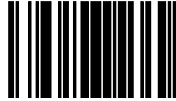
2



3

Use the bar codes in this section to enter numbers and characters as you would select digits/characters from a keypad.

Scan your selection from the bar codes below. You'll need to cover any unused bar codes on this and the facing page to ensure that the scanner reads only the bar code you intend to scan.



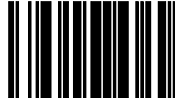
4



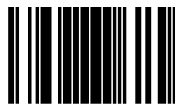
5

Use the bar codes in this section to enter numbers and characters as you would select digits/characters from a keypad.

Scan your selection from the bar codes below. You'll need to cover any unused bar codes on this and the facing page to ensure that the scanner reads only the bar code you intend to scan.



6



7

Use the bar codes in this section to enter numbers and characters as you would select digits/characters from a keypad.

Scan your selection from the bar codes below. You'll need to cover any unused bar codes on this and the facing page to ensure that the scanner reads only the bar code you intend to scan.



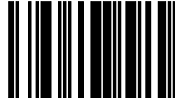
8



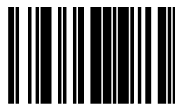
9

Use the bar codes in this section to enter numbers and characters as you would select digits/characters from a keypad.

Scan your selection from the bar codes below. You'll need to cover any unused bar codes on this and the facing page to ensure that the scanner reads only the bar code you intend to scan.



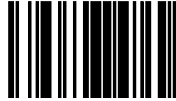
A



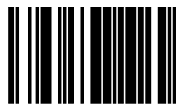
B

Use the bar codes in this section to enter numbers and characters as you would select digits/characters from a keypad.

Scan your selection from the bar codes below. You'll need to cover any unused bar codes on this and the facing page to ensure that the scanner reads only the bar code you intend to scan.



C



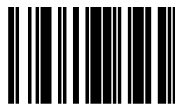
D

Use the bar codes in this section to enter numbers and characters as you would select digits/characters from a keypad.

Scan your selection from the bar codes below. You'll need to cover any unused bar codes on this and the facing page to ensure that the scanner reads only the bar code you intend to scan.



E



F

Appendix D

Host Commands

Accepting Commands from an RS-232 Scanner Host

The scanner responds to the following RS-232 commands:

COMMAND	ASCII	HEX	COMMENT
Enable Scanner	E	0x45	
Disable Scanner	D	0x44	
Reset Scanner	R	0x52	
Not On File Indication	F	0x46	Long series of beeps
Beep Good Read Tone	B	0x42	Beeps if Good Read Beep is enabled
Force Good Read Tone		0x01	Beeps regardless of beep setting
Bel		0x07	Force Good Read Tone
Identification request	i	0x69	Returns long response ^a
Health request	h	0x68	Returns long response ^a
Status request	s	0x73	Returns long response ^a

a. Call Tech Support for information.

If one of the above commands is received, the scanner will perform the steps indicated for the command. Host commands for other interfaces is also available. Contact Tech Support for more details.

NOTES

Appendix E

Handheld Data Format Requirements

This appendix provides application notes to describe the general format of data that can be accepted by the scanner through the auxilliary port as transmitted from a handheld scanner.

Handheld Data Format Requirements General

- 9600 bps, 8 data bits, 2 stop bits, no parity.
- RTS is used to "bracket" the data received from the handheld: RTS must be asserted high during data transmission, and de-asserted after label transmission is complete. No other flow control mechanisms are required or supported. The de-assertion of the RTS signal must occur no later than 50 milliseconds from the complete transmission of the last character of the transmitted data.
- The time between character transmission can be no longer than 50 milliseconds.
- Symbologies requiring fixed lengths (UPC/EAN) will enforce length requirements for validation of the label.
- Handheld scanner will be required to transmit start and stop characters for Codabar and Code 39 labels.
- Appropriate industrial length requirements will be enforced (if configured) for validation of the label.
- Maximum label lengths will be enforced for label validation (i.e. labels longer than the maximum label size will not be validated).
- Standard Datalogic formats generally use a single prefix character. The specific formats are provided below.

Datalogic Handheld Data Format Requirements

The following sections describe label transmission formats that are typically observed in factory configurations of Datalogic handheld scanners.

DataBar Omnidirectional

- Prefix must be ASCII characters 'R4'
- Check character must be included in label
- Application identifier "01" must follow the prefix and precede the base label
- Label length excluding prefix characters must be 16 characters.
- Example: 'R40101044123456789'

DataBar Expanded

- Prefix must be ASCII characters 'R4'
- Check character must be included in label

UPC-A

- System number must be included in label data.
- Check digit must be included in label data and is assumed to be correct.
- Prefix must be an ASCII character 'A' - total length including prefix must be 13.
- Example: 'A060992011187'.

UPC-A with 2-Digit Supplemental

- System number must be included in label data.
- Check digit must be included in label data and is assumed to be correct.
- Supplemental data is appended to base label.
- Prefix must be an ASCII character 'A' - total length including prefix must be 15.
- Example: 'A06099201118712'.

UPC-A with 5-Digit Supplemental

- System number must be included in label data
- Check digit must be included in label data and is assumed to be correct
- Prefix must be an ASCII character 'A' - total length including prefix must be 18
- Example: 'A06099201118712345'

UPC-A with Code 128 Supplemental

- System number must be included in label data.
- Check digit must be included in label data and is assumed to be correct.
- Supplemental data is appended to base label.
- Prefix must be an ASCII character 'A' - total length including prefix must be greater or equal to 19 Code 128 Supplemental codes are variable length having a minimum of 2 data characters).
- Characters immediately following base label must be of the form '8100', '8101' or '8102'.
- Example: 'A0609920111878100000951'.

UPC-E

- System number must be included in label data
- Check digit must be included in label data and is assumed to be correct
- Prefix must be an ASCII character 'E' - total length including prefix must be 9
- Example: 'E09988750'

UPC-E with 2-Digit Supplemental

- System number must be included in label data.
- Check digit must be included in label data and is assumed to be correct.
- Supplemental data is appended to base label.
- Prefix must be an ASCII character 'E' - total length including prefix must be 11.
- Example: 'E0998875012'.

UPC-E with 5-Digit Supplemental

- System number must be included in label data.
- Check digit must be included in label data and is assumed to be correct.
- Prefix must be an ASCII character 'E' - total length including prefix must be 14.
- Example: 'E0998875012345'.

UPC-E with Code 128 Supplemental

- System number must be included in label data.
- Check digit must be included in label data and is assumed to be correct.
- Supplemental data is appended to base label.
- Prefix must be an ASCII character 'E' - total length including prefix must be greater or equal to 15 (code 128 Supplemental codes are variable length having a minimum of 2 data characters).
- Characters immediately following base label must be of the form '8100', '8101' or '8102'.
- Example: 'E099887508101000951'.

EAN-8

- Check digit must be included in label data and is assumed to be correct
- Prefix must be an ASCII characters 'FF' - total length including prefix must be 10
- Example: 'FF00210126'

EAN-8 with 2-Digit Supplemental

- Check digit must be included in label data and is assumed to be correct.
- Supplemental data is appended to base label.
- Prefix must be an ASCII characters 'FF' - total length including prefix must be 12.
- Example: 'FF0021012612'.

EAN-8 with 5-Digit Supplemental

- Check digit must be included in label data and is assumed to be correct.
- Prefix must be an ASCII characters 'FF' - total length including prefix must be 15.
- Example: 'FF0021012612345'.

EAN-8 with Code 128 Supplemental

- Check digit must be included in label data and is assumed to be correct.
- Supplemental data is appended to base label.
- Prefix must be an ASCII characters 'FF' - total length including prefix must be greater than 16 (code 128 Supplemental codes are variable length having a minimum of 2 data characters).
- Characters immediately following base label must be of the form '8100', '8101' or '8102'.
- Example: 'FF002101268102000951'.

EAN-13

- Check digit must be included in label data and is assumed to be correct
- Prefix must be an ASCII character 'F'- total length including prefix must be 14
- Example: 'F1101234567891'

EAN-13 with 2-Digit Supplemental

- Check digit must be included in label data and is assumed to be correct
- Supplemental data is appended to base label
- Prefix must be an ASCII character 'F'- total length including prefix must be 16
- Example: 'F110123456789112'

EAN-13 with 5-Digit Supplemental

- Check digit must be included in label data and is assumed to be correct.
- Prefix must be an ASCII character 'F'- total length including prefix must be 19.
- Example: 'F110123456789112345'.

EAN-13 with Code 128 Supplemental

- Check digit must be included in label data and is assumed to be correct
- Supplemental data is appended to base label
- Prefix must be an ASCII character 'F'- total length including prefix must be greater or equal to 20 (code 128 Supplemental codes are variable length having a minimum of 2 data characters)
- Characters immediately following base label must be of the form '8100', '8101' or '8102'
- Example: 'F11012345678918100000951'

Code 39

- Check character must be included in label data.
- Label length including start, stop and check characters and excluding prefix character must meet requirements imposed by the main scanner's fixed or variable label length control for this symbology type.
- Start and stop characters "*" must be included in label.
- Prefix must be an ASCII character '*'.
- Example : '**Code 39.TEST*'.

Code 39-Pharmacode

- Check character must be included in label data.
- Label length including start, stop and check characters and excluding prefix character must meet requirements imposed by the main scanner's fixed or variable label length control for this symbology type.
- Start and stop characters "*" must be included in label.
- Prefix must be an ASCII character 'p'.
- Example: 'p*123456789*'.

I 2 of 5

- Check character must be included in label data.
- Label length including check characters and excluding prefix character must meet requirements imposed by the main scanner's fixed or variable label length control for this symbology type.
- Prefix must be an ASCII character 'i'.
- Example: 'i0123456789'.

Standard 2 of 5

- Check character must be included in label data.
- Label length including check characters and excluding prefix characters must meet requirements imposed by the main scanner's fixed or variable label length control for this symbology type.
- Prefix must be an ASCII character 's'.
- Example: 's0123456789'.

Codabar

- Check character must be included in label data.
- Label length including check character and excluding prefix character must meet requirements imposed by the main scanner's fixed or variable label length control for this symbology type.
- Prefix must be an ASCII character '%'.
- Start stop character sets must meet the matching requirement set forth by the scanner configuration item *Codabar Start Stop Character Match*.
- Start stop character sets must be of the form ABCD/ABCD and must be included in the label.
- Example: '%s\$99.95s' (the lower case 's' at each end of the example is a placeholder for the start stop character set).

Code 128

- Prefix must be an ASCII character '#'.
- Label length excluding prefix character must meet requirements imposed by the main scanner's fixed or variable label length control for this symbology type.
- Function characters may be transmitted as a hexadecimal value 8x. Where x correlates to function characters 1 thru 4 as follows:
 - x80 = function code 1
 - x81 = function code 2
 - x82 = function code 3
 - x83 = function code 4
- For Code 128 programming labels the format is of the general form '#/82nnnnn/r ' - /82 is hexadecimal 82 and /r is carriage return.
- Example: '#Code_128.Test'.

MSI/Plessey

- Check character must be included in label data.
- Label length including check character and excluding prefix character must meet requirements imposed by the main scanner's fixed or variable label length control for this symbology type.
- Prefix must be an ASCII character '@'.
- Example: '@144769254'.

Code 93

- Prefix must be an ASCII character '&'.
- Label length excluding prefix character must meet requirements imposed by the main scanner's fixed or variable label length control for this symbology type.
- Example: '&Code93-test'.

AIM Formats

AIM specifies a 3-character string that is attached as a prefix to the label data for transmission. Because AIM specifies one identifier for UPC-A, UPC-E and EAN-13 labels, UPC-A, UPC-E and EAN-13 will be received from the handheld and transmitted to the POS by the scanner as EAN-13. Using this form of identification, the ']' character must be the first character in the label received from the handheld. Further identification of the label is specified in the section below. The AIM identifiers on the received label may or may not be transmitted to the POS and are controlled according to the data formatting settings of the scanner.

The following sections describe the prefix strings and identify what specific label characteristics can be supported.

If a label does not have one of the AIM identifiers specified below and the first three characters of the label data fit the following qualifications:

- the first character is a ']'
- the second character is a capital letter or a small letter
- the third character is a digit

...then the label is transmitted to the host with the AIM identifier still appended to the beginning of the label data.

UPC-A

- AIM does not specify UPC-A as a separate symbology using this transmission format - labels will be transmitted as EAN-13.
- Example: ']E00060992011187'.

UPC-E

- AIM does not specify UPC-E as a separate symbology using this transmission format - labels will be transmitted as EAN-13.
- Example: ']E00000000998875'.

EAN-13

- Check digit must be included in label data and is assumed to be correct.

- Prefix must be ASCII characters 'J]E0' - total length including prefix must be 16.
- Example: 'J]E01101234567891'.

EAN-8

- Check digit must be included in label data and is assumed to be correct.
- Prefix must be ASCII characters 'J]E4' - total length including prefix must be 11.
- Example: 'J]E400210126'.

2-Digit Supplemental

- Supplemental data is appended to any EAN base label.
- Prefix must be ASCII characters 'J]E1'.
- length of Supplemental data including prefix must be 5. Total required length is 21 for EAN-13 and 16 for EAN-8.
- Prefix for the main body portion of the label for UPCA/UPCE/EAN13 can be J]E0 or J]E3.
- If the main body prefix for UPCA/UPCE/EAN13 is J]E0, then the 2-digit addon portion of the label must have a prefix of J]E1.

Examples: addon portion is highlighted data is underlined.

UPC-A 2-Digit addon	'J]E00060992011187J]E1 <u>12</u> '
UPC-E 2-Digit addon	'J]E00000000998875J]E1 <u>12</u> '
EAN-8 2-Digit addon	'J]E400210126J]E1 <u>12</u> '
EAN-13 2-Digit addon	'J]E01101234567891J]E1 <u>12</u> '
UPC-A	J]E3006099201118712
UPC-E	J]E3000000099887512
EAN-13	J]E3110123456789112

5-Digit Supplemental

- Supplemental data is appended to any EAN base label.
- Prefix must be ASCII characters 'J'E2'.
- Length of supplemental data including prefix must be 8. Total required length is 24 for EAN-13 and 19 for EAN-8.
- Prefix for the main body portion of the label for UPCA/UPCE/EAN13 can be J'E0 or J'E3.
- If the main body prefix for UPCA/UPCE/EAN13 is J'E0, then the 5-digit addon portion of the label must have a prefix of J'E2.

Examples: addon portion is highlighted data is underlined.

UPC-A 5-Digit addon	'J'E00060992011187J'E212345'
UPC-E 5-Digit addon	'J'E00000000998875J'E212345'
EAN-8 5-Digit addon	'J'E400210126J'E212345'
EAN-13 5-Digit addon	'J'E01101234567891J'E212345'
UPC-A	J'E3006099201118712345
UPC-E	J'E3000000099887512345
EAN-13	J'E3110123456789112345

Code 39

- Check character must be included in label data.
- Label length including start, stop and check characters and excluding prefix characters must meet requirements imposed by the main scanner's fixed or variable label length control for this symbology type.
- Start and stop characters "*" must be included in label.
- Prefix must be ASCII characters ']A0' or ']A1'.
- Example: '*]A0Code 39.TEST*'

Codabar

- Check character must be included in label data.
- Label length including check character and excluding prefix characters must meet requirements imposed by the main scanner's fixed or variable label length control for this symbology type.
- Prefix must be ASCII characters ']F0'.
- Start stop character sets must meet the matching requirement set forth by the scanner configuration item *Codabar Start Stop Character Match*.
- Start stop character sets s must be of the form ABCD/ABCD and must be included in the label.
- Example: ']F0s\$99.95s' (the lower case 's' at each end of the example is a placeholder for the start stop character set).

MSI/Plessey

- Check character must be included in label data.
- Label length including check character and excluding prefix characters must meet requirements imposed by the main scanner's fixed or variable label length control for this symbology type.
- Prefix must be ASCII characters ']M0'.
- Example: ']M0144769254'.

Code 93

- Prefix must be ASCII characters ']G0'.
- Label length excluding prefix characters must meet requirements imposed by the main scanner's fixed or variable label length control for this symbology type.
- Example : ']G0Code93-test'.

DataBar Omnidirectional

- Prefix must be ASCII characters ']e0'.
- Check character must be included in label.
- Label length excluding prefix characters must be 14 characters.
- Example: ']e001044123456789'.

DataBar Expanded

- Prefix must be ASCII characters ']e0'.
- Label length excluding prefix characters must be at least 1 character. Maximum length is the maximum label size supported by the scanner.
- Example: ']e001900123456789083103001750'.

I 2 of 5

- Check character must be included in label data.
- Label length including check characters and excluding prefix characters must meet requirements imposed by the main scanner's fixed or variable label length control for this symbology type.
- Prefix must be ASCII characters ']I0', ']I1' or ']I2' (other prefixes specify different check character properties which are not supported).
- Example: ']I10123456789'.

Standard 2 of 5

- Check character must be included in label data.
- Label length including check characters and excluding prefix characters must meet requirements imposed by the main scanner's fixed or variable label length control for this symbology type.
- Prefix must be an ASCII character ']S0' (other prefixes specify different check character properties which are not supported).
- Example: ']S00123456789'.

Code 128 / EAN128

- Prefix must be either ASCII characters ']C0', ']C1' or ']C2'.
- Label length excluding prefix character must meet requirements imposed by the main scanner's fixed or variable label length control for this symbology type.
- If EAN-128 Symbology is Enabled and prefix is ']C1', label will be identified as an EAN128 otherwise it is identified as a Code 128.
- A prefix of ']C0' designates that no function code is present in the 1st or 2nd character position.
- A prefix of ']C2' designates that a function code 1 is present in the 2nd character.
- Example : ']C0Code_128.Test'.

NOTES

Appendix F

Keyboard Function Key Mappings

Keyboard Model Cross Reference

[Table F-410](#) summarizes the keyboard models, their defined protocol, scancode set, and some unique features. The remaining tables in this chapter provide the function key maps associated with each of the scancode sets.

Table F-1. Keyboard Model Cross Reference

Model Type	I/F ID	Transmission Protocol	Scancode Set	Func. Key Map Support	Use Country Mode
PC/XT Foreign ALT Mode	Wedge A	PC/XT	Scan Set 1	No	No
AT; PS/2 25-286; PS/2 30-286; PS/2 50, 50Z; PS/2 60,70,80,90,95 Foreign ALT Mode	Wedge B	AT/PS2	Scan Set 2	No	No
PS/2 25 and 30 Foreign ALT Mode	Wedge C	AT/PS2	Scan Set 1	No	No
PC/XT U.S. Mode	Wedge D	PC/XT	Scan Set 1	Yes	No
AT; PS/2 25-286; PS/2 30-286; PS/2 50, 50Z; PS/2 60,70,80,90,95 U.S. Mode + specific country support	Wedge E	AT/PS2	Scan Set 2	Yes	Yes
PS/2 25 and 30 U.S. Mode	Wedge F	AT/PS2	Scan Set 1	Yes	No
IBM 3xxx Terminals (122-key keyboard)	Wedge G	AT/PS2	Scan Set 3	Yes	No
IBM 3xxx Terminals (102-key keyboard)	Wedge H	AT/PS2	Scan Set 3	Yes	No
PS55 5530T with JAPANESE DOS (TDOS)	Wedge I	AT/PS2	Japanese DOS	Yes	No
NEC 9801	Wedge J	NEC 9801	NEC 9801	Yes	No

Table F-2. Scanset 1 Function Key Map

ASCII (hex)	ASCII code	Key	Scancode
00	NUL	ALT right Make	E0h 38h
01	SOH	ALT right Break	E0h B8h
02	STX	ALT left Make	38h
03	ETX	ALT left Break	B8h
04	EOT	CTRL left Make	1Dh
05	ENQ	CTRL left Break	9Dh
06	ACK	CTRL right Make	E0h 1Dh
07	BEL	CTRL right Break	E0h 9Dh
08	BS	BS	0Eh
09	HT	TAB right	0Fh
0A	LF	RIGHT arrow (inner keypad)	4Dh + E0
0B	VT	TAB left	0Fh + S
0C	FF	Enter (inner keypad)	1Ch + E0
0D	CR	CR	1Ch
0E	SO	INSERT (inner keypad)	52h + E0
0F	SI	PAGE UP (inner keypad)	49h + E0
10	DLE	PAGE DOWN (inner keypad)	51h + E0
11	DC1	HOME (inner keypad)	47h + E0
12	DC2	LEFT arrow (inner keypad)	4Bh + E0
13	DC3	DOWN arrow (inner keypad)	50h + E0
14	DC4	UP arrow (inner keypad)	48h + E0

Table F-3. Scanset 2 Function Key Map

ASCII (hex)	ASCII code	Key	Scancode
00	NUL	ALT right Make	E0h 11h
01	SOH	ALT right Break	E0h F0h 11h
02	STX	ALT left Make	11h
03	ETX	ALT left Break	F0h 11h
04	EOT	CTRL left Make	14h
05	ENQ	CTRL left Break	F0h 14h
06	ACK	CTRL right Make	E0h 14h
07	BEL	CTRL right Break	E0h F0h 14h
08	BS	BS	66h
09	HT	TAB right	0Dh
0A	LF	RIGHT arrow (inner keypad)	74h + E0
0B	VT	TAB left	0Dh + S
0C	FF	Enter (right keypad)	5Ah + E0
0D	CR	CR	5Ah
0E	SO	INSERT (inner keypad)	70h + E0
0F	SI	PAGE UP (inner keypad)	7Dh + E0
10	DLE	PAGE DOWN (inner keypad)	7Ah + E0
11	DC1	HOME (inner keypad)	6Ch + E0
12	DC2	LEFT arrow (inner keypad)	6Bh + E0
13	DC3	DOWN arrow (inner keypad)	72h + E0
14	DC4	UP arrow (inner keypad)	75h + E0
15	NAK	F6	0Bh
16	SYN	F1	05h
17	ETB	F2	06h
18	CAN	F3	04h
19	EM	F4	0Ch
1A	SUB	F5	03h
1B	ESC	ESC	76h
1C	FS	F7	83h
1D	GS	F8	0Ah
1E	RS	F9	01h
1F	US	F10	09h

Table F-4. Scanset 3, 102-Key Function Key Map

ASCII (hex)	ASCII code	Key	Scancode
00	NUL	ALT right Make	39h
01	SOH	ALT right Break	F0h 39h
02	STX	ALT left Make	19h
03	ETX	ALT left Break	F0h 19h
04	EOT	CTRL left Make	11h
05	ENQ	CTRL left Break	F0h 11h
06	ACK	CTRL right Make	58h
07	BEL	CTRL right Break	F0h 58h
08	BS	BS	66h
09	HT	TAB right	0Dh
0A	LF	RIGHT arrow (inner keypad)	6Ah
0B	VT	TAB left	0Dh + S
0C	FF	Enter (inner keypad)	79h
0D	CR	CR	5Ah
0E	SO	INSERT (inner keypad)	67h
0F	SI	PAGE UP (inner keypad)	6Fh
10	DLE	PAGE DOWN (inner keypad)	6Dh
11	DC1	HOME (inner keypad)	6Eh
12	DC2	LEFT arrow (inner keypad)	61h
13	DC3	DOWN arrow (inner keypad)	60h
14	DC4	UP arrow (inner keypad)	63h
15	NAK	F6	2Fh
16	SYN	F1	07h
17	ETB	F2	0Fh
18	CAN	F3	17h
19	EM	F4	1Fh
1A	SUB	F5	27h
1B	ESC	ESC	08h
1C	FS	F7	37h
1D	GS	F8	3Fh
1E	RS	F9	47h
1F	US	F10	4Fh

Table F-5. Scanset 3 122-Key Function Key Map

ASCII (hex)	ASCII code	Key	Scancode
00	NUL	ALT Right Make	39h
01	SOH	ALT Right Break	F0h 39h
02	STX	ALT left Make	19h
03	ETX	ALT left Break	F0h 19h
04	EOT	CTRL left (RESET) Make only	11h
05	ENQ	CTRL left (RESET) Make/Break	11h F0h 11h
06	ACK	ONLINE Enter Make only	58h
07	BEL	ONLINE Enter Make/Break	58h F0h 58h
08	BS	BS	66h
09	HT	TAB right	0Dh
0A	LF	RIGHT arrow (inner keypad)	6Ah
0B	VT	TAB left	0Dh + S
0C	FF	CR (FIELD EXIT) Make only	5Ah F0h 5Ah
0D	CR	CR (FIELD EXIT) Make/Break	5Ah
0E	SO	INSERT (inner keypad)	65h
0F	SI	FIELD +	79h
10	DLE	FIELD -	7Ch
11	DC1	HOME (inner keypad)	62h
12	DC2	LEFT arrow (inner keypad)	61h
13	DC3	DOWN arrow (inner keypad)	60h
14	DC4	UP arrow (inner keypad)	63h
15	NAK	F6	2Fh
16	SYN	F1	07h
17	ETB	F2	0Fh
18	CAN	F3	17h
19	EM	F4	1Fh
1A	SUB	F5	27h
1B	ESC	ESC	08h
1C	FS	F7	37h
1D	GS	F8	3Fh
1E	RS	F9	47h
1F	US	F10	4Fh

Table F-6. Japanese DOS Function Key Map

ASCII value	ASCII code	Key	Scancode
00h	NUL	ALT right Make	31h
01h	SOH	ALT right Break	B1h
02h	STX	ALT left Make	31h
03h	ETX	ALT left Break	B1h
04h	EOT	CTRL left Make	41h
05h	ENQ	CTRL left Break	C1h
06h	ACK	CTRL right Make	41h
07h	BEL	CTRL right Break	C1h
08h	BS	BS	3Eh
09h	HT	TAB right	3Ch
0Ah	LF	RIGHT arrow (inner keypad)	4Dh
0Bh	VT	TAB left	3Ch + S
0Ch	FF	Enter (right keypad)	60h
0Dh	CR	CR	3Bh
0Eh	SO	INSERT (inner keypad)	52h
0Fh	SI	PAGE UP (inner keypad)	49h
10h	DLE	PAGE DOWN (inner keypad)	51h
11h	DC1	HOME (inner keypad)	4Ch
12h	DC2	LEFT arrow (inner keypad)	4Bh
13h	DC3	DOWN arrow (inner keypad)	4Ah
14h	DC4	UP arrow (inner keypad)	4Eh
15h	NAK	F6	6Dh
16h	SYN	F1	68h
17h	ETB	F2	69h
18h	CAN	F3	6Ah
19h	EM	F4	6Bh
1Ah	SUB	F5	6Ch
1Bh	ESC	ESC	3Dh
1Ch	FS	F7	6Eh
1Dh	GS	F8	6Fh
1Eh	RS	F9	70h
1Fh	US	F10	71h

Table F-7. NEC 9801-Key Function Key Map

ASCII value	ASCII code	Key	Scancode
00h	NUL	unused	n/a
01h	SOH	CR	1Ch
02h	STX	CAPS LOCK ON (make)	71h
03h	ETX	CAPS LOCK OFF (break)	F1h
04h	EOT	CTRL left Make	74h
05h	ENQ	CTRL left Break	F4h
06h	ACK	CTRL-C	60h
07h	BEL	n/a	n/a
08h	BS	BS	0Eh
09h	HT	TAB right	0Fh
0Ah	LF	RIGHT arrow (inner keypad)	3Ch
0Bh	VT	TAB left	0Fh + S
0Ch	FF	DELETE	39h
0Dh	CR	CR	1Ch
0Eh	SO	INSERT (inner keypad)	38h
0Fh	SI	KATAKANA LOCK ON (Make)	72h
10h	DLE	KATAKANA LOCK OFF (Break)	F2h
11h	DC1	HOME (inner keypad)	3Eh
12h	DC2	LEFT arrow (inner keypad)	3Bh
13h	DC3	DOWN arrow (inner keypad)	3Dh
14h	DC4	UP arrow (inner keypad)	3Ah
15h	NAK	F6	67h
16h	SYN	F1	62h
17h	ETB	F2	63h
18h	CAN	F3	64h
19h	EM	F4	65h
1Ah	SUB	F5	66h
1Bh	ESC	ESC	00h
1Ch	FS	F7	68h
1Dh	GS	F8	69h
1Eh	RS	F9	6Ah
1Fh	US	F10	6Bh

Table F-8. USB Keyboard Function Key Usage Map

ASCII	Key Value	Usage Name
00	NUL	ALT right Make
01	SOH	ALT right Break
02	STX	F11
03	ETX	F12
04	EOT	GUI right Make
05	ENQ	GUI right Break
06	ACK	CTRL right Make
07	BEL	CTRL right Break
08	BS	BS
09	HT	TAB right
0A	LF	RIGHT arrow (inner keypad)
0B	VT	TAB left
0C	FF	Enter (right keypad)
0D	CR	CR
0E	SO	INSERT (inner keypad)
0F	SI	PAGE UP (inner keypad)
10	DLE	PAGE DOWN (inner keypad)
11	DC1	HOME (inner keypad)
12	DC2	LEFT arrow (inner keypad)
13	DC3	DOWN arrow (inner keypad)
14	DC4	UP arrow (inner keypad)
15	NAK	F6
16	SYN	F1
17	ETB	F2
18	CAN	F3
19	EM	F4
1A	SUB	F5
1B	ESC	ESC
1C	FS	F7
1D	GS	F8
1E	RS	F9
1F	US	F10

NOTES

NOTES

NOTES

ASCII Character Set

The table on this page shows a set of ASCII characters and their corresponding Hex Values. The Hex Values in this table are needed for setting symbology specific label identifiers, as well as enabling custom prefix and suffix characters.

ASCII Char.	Hex No.	ASCII Char.	Hex No.	ASCII Char.	Hex No.	ASCII Char.	Hex No.
NUL	00	SP	20	@	40	'	60
SOH	01	!	21	A	41	a	61
STX	02	"	22	B	42	b	62
ETX	03	#	23	C	43	c	63
EOT	04	\$	24	D	44	d	64
ENQ	05	%	25	E	45	e	65
ACK	06	&	26	F	46	f	66
BEL	07	'	27	G	47	g	67
BS	08	(28	H	48	h	68
HT	09)	29	I	49	i	69
LF	0A	*	2A	J	4A	j	6A
VT	0B	+	2B	K	4B	k	6B
FF	0C	,	2C	L	4C	l	6C
CR	0D	-	2D	M	4D	m	6D
SO	0E	.	2E	N	4E	n	6E
SI	0F	/	2F	O	4F	o	6F
DLE	10	0	30	P	50	p	70
DC1	11	1	31	Q	51	q	71
DC2	12	2	32	R	52	r	72
DC3	13	3	33	S	53	s	73
DC4	14	4	34	T	54	t	74
NAK	15	5	35	U	55	u	75
SYN	16	6	36	V	56	v	76
ETB	17	7	37	W	57	w	77
CAN	18	8	38	X	58	x	78
EM	19	9	39	Y	59	y	79
SUB	1A	:	3A	Z	5A	z	7A
ESC	1B	;	3B	[5B	{	7B
FS	1C	<	3C	\	5C		7C
GS	1D	=	3D]	5D	}	7D
RS	1E	>	3E	^	5E	~	7E
US	1F	?	3F	_	5F	DEL	7F

Australia

Datalogic Scanning Pty Ltd
Telephone: [61] (2) 9870 3200
australia.scanning@datalogic.com

Japan

Datalogic Scanning KK
Telephone: 81 (0)3 3491 6761
japan.scanning@datalogic.com

France and Benelux

Datalogic Scanning Sarl
Telephone: [33].01.64.86.71.00
france.scanning@datalogic.com

Latin America

Datalogic Scanning, Inc
Telephone: (305) 591-3222
latinamerica.scanning@datalogic.com

Germany

Datalogic Scanning GmbH
Telephone: 49 (0) 61 51/93 58-0
germany.scanning@datalogic.com

Singapore

Datalogic Scanning Singapore PTE LTD
Telephone: (65) 6435-1311
singapore.scanning@datalogic.com

India

Datalogic Scanning India
Telephone: 91- 22 - 64504739
india.scanning@datalogic.com

Spain and Portugal

Datalogic Scanning Sarl Sucursal en España
Telephone: 34 91 746 28 60
spain.scanning@datalogic.com

Italy

Datalogic Scanning SpA
Telephone: [39] (0) 39/62903.1
italy.scanning@datalogic.com

United Kingdom

Datalogic Scanning LTD
Telephone: 44 (0) 1923 809500
uk.scanning@datalogic.com



www.scanning.datalogic.com

Datalogic Scanning, Inc.

959 Terry Street
Eugene, OR 97402
Telephone: (541) 683-5700
Fax: (541) 345-7140

