

# ***DT105X / PB105 Series***

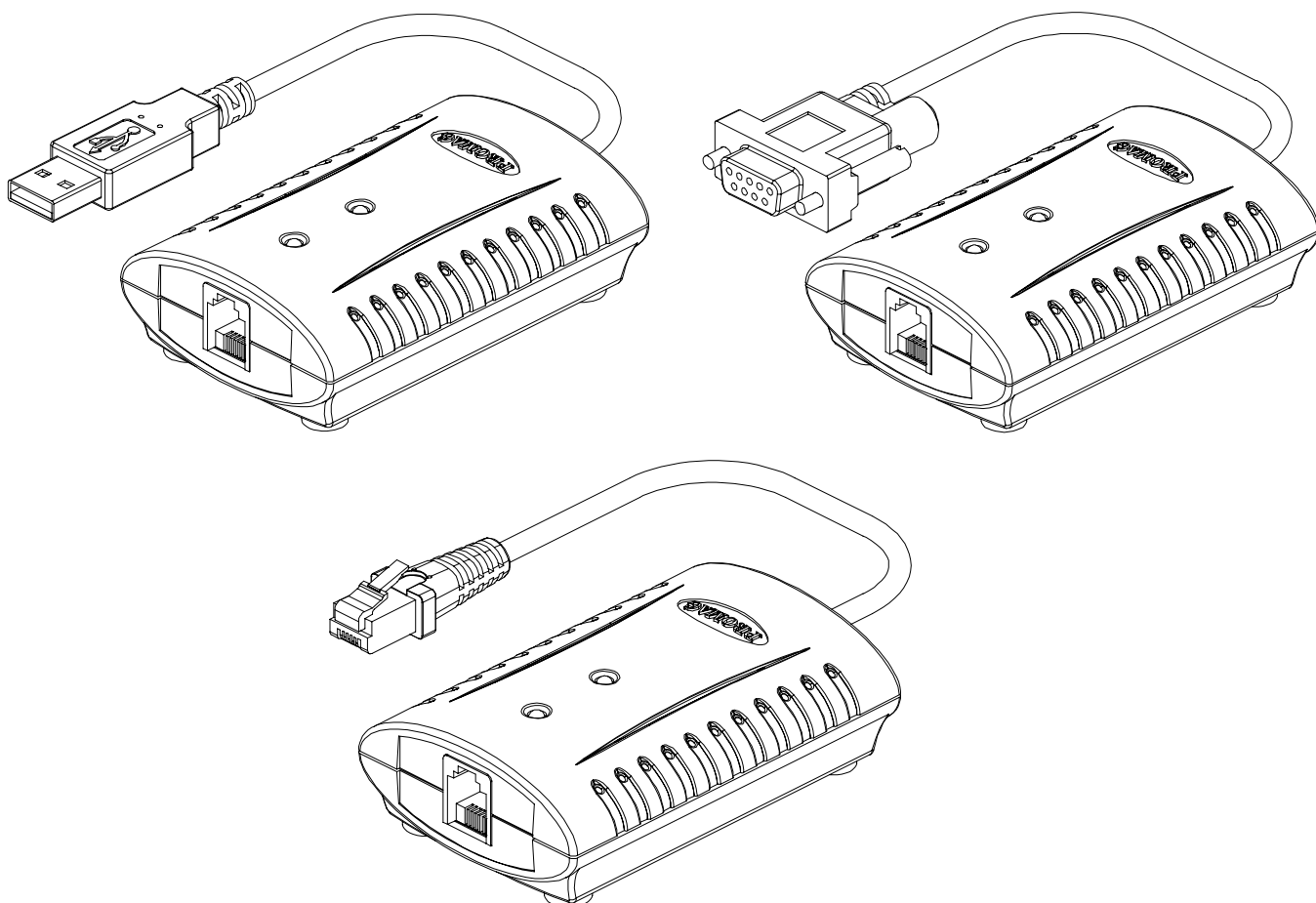

## **Cash Drawer Trigger & Printer Beeper User's Manual**

# Contents

Information .....	1
Technical And Operational Description .....	3
Connections .....	5
Load Test .....	7
USB Driver Setup .....	8
Specifications .....	12
Communication Protocol .....	13
Application Note .....	14

## FCC COMPLIANCE STATEMENT

This equipment has been tested and found to comply with the limits for a Class A digital device, pursuant to Part 15 of the FCC Rules. These limits are designed to provide reasonable protection against harmful interference when the equipment is operated in a commercial environment. This equipment generates, uses, and can radiate radio frequency energy and, if not installed and used in accordance with the instruction manual, may cause harmful interference to radio communication.

Operation of this equipment in a residential area is likely to cause harmful interference in which case the user will be required to correct the interference at his own expense.

## GIGA-TMS Inc.

**Office :** 8F No 31 Lane 169, Kang-Ning St., Hsi-Chih, Taipei, Taiwan

**Tel :** 886-2-2695-4214











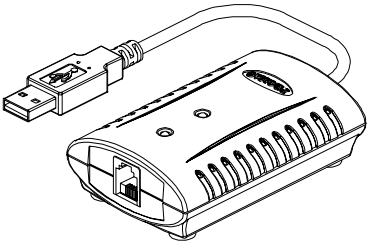

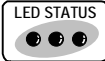

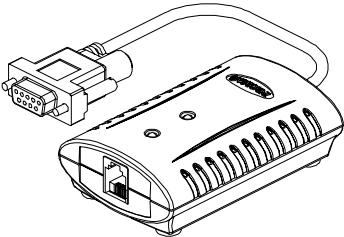
**Fax :** 886-2-2695-4213

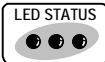
**Web site :** <http://www.gigatms.com.tw>

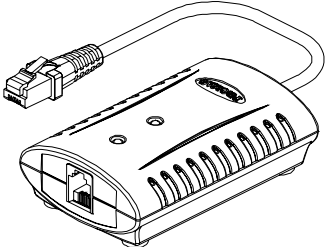
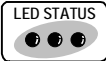
**E-mail :** [promag@ms24.hinet.net](mailto:promag@ms24.hinet.net)

# Information

## Cash Drawer Trigger & Printer Beeper

MACHINE TYPE	FUNCTION			
 <p><b>DT105U</b> Cash Drawer Trigger USB Interface Command control and RTS/DTR signal control</p>				
 <p><b>DT105R</b> Cash Drawer Trigger RS232 Interface Command control and RTS/DTR signal control</p>				
 <p><b>PB105</b> Printer Beeper</p>				
				

## ■ Standard Package

### DT105U

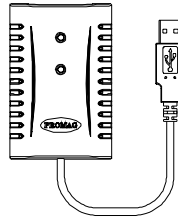

Main unit  
( DT105U )

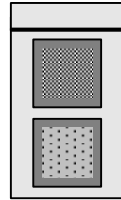

Velcro Fastener  
( ASY-M93-1049-46 )

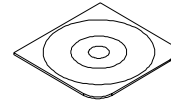

CD-ROM  
( DISK5140 )

### DT105R

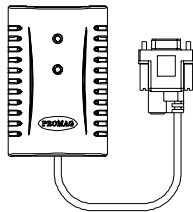

Main unit  
( DT105R )

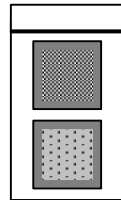

Velcro Fastener  
( ASY-M93-1049-46 )

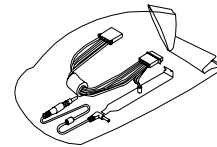

Power Plug  
( ASY-M93-6022-2 )

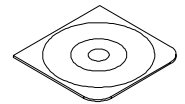

CD-ROM  
( DISK5140 )

### PB105

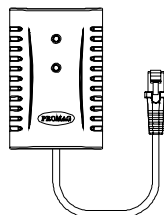

Main unit  
( PB105 )

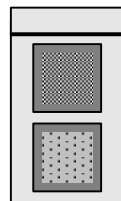

Velcro Fastener  
( ASY-M93-1049-46 )

## ■ Optional

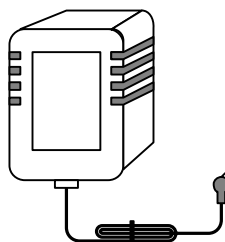

Power Adaptor  
DC5V/120VAC ( APR-1024 ) or DC5V/230VAC ( APR-1010 )

# Technical And Operational Description

## ■ Front Panel and Operations

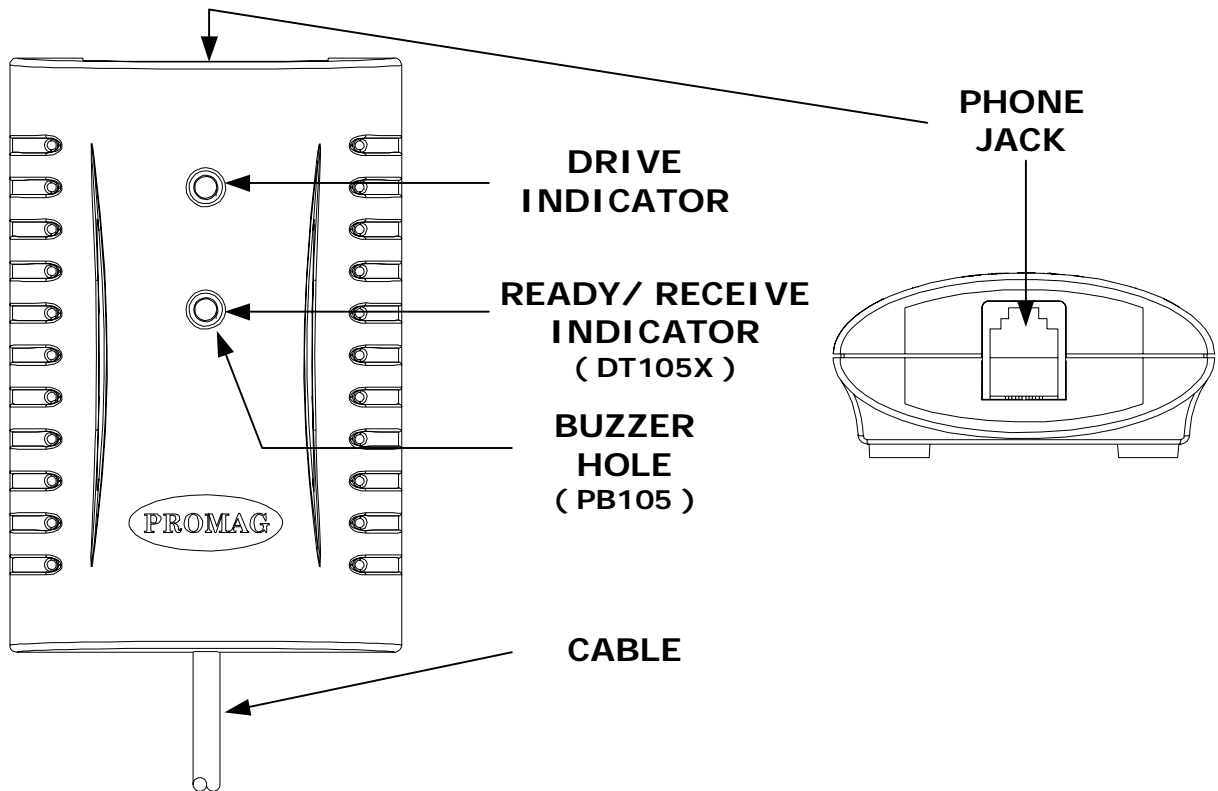

- **DRIVE INDICATOR ( Red color )**  
The status LED provides visual indication of the device output operating
- **READY/ RECEIVE INDICATOR ( Green color ) <DT105X>**  
Indicating the device is ready to accept new inputs and communication status from Host.
- **BUZZER HOLE < PB105 >**  
The sound's hole for Buzzer.
- **PHONE JACK**  
For connection to Cash Drawer .
- **CABLE**  
Connect to USB or RS232 ( include power supply ) interface.

## ■ Introduction

This manual provides basic information about the Models of DT105U (DT105R) Universal Serial Bus (RS232 Serial Port) Cash Drawer Triggers, and the PB105 Printer Beeper.

The DT105U(DT105R) Cash Drawer Trigger is designed to provide USB (RS232) interfacing to the cash drawer. This allows cash drawers, previously connected to POS printers and cash registers, to be connected to a USB (RS232) port of the computer.

The DT105U USB Trigger uses a Virtual Serial Port Driver, making it appear to have the software like a standard RS232 Serial Port. This way the existing POS Software can communicate with the USB Cash Drawer Trigger as if it were connected to a Serial Port. A unique serial number is assigned to each USB Trigger Module and the Driver Software will assign the next available Serial Port to each device it recognises (multiple Triggers can be used on one PC).

The DT105U(DT105R) module is designed to accept modular cash drawer connectors. All standard POS printer drawer open commands are used to trigger the device and the ESC/POS status command is also available to read the drawers open or closed condition.

- \* **DT105U** is to open the cash drawer when it receives the trigger command or the RTS/DTR signal control from the computer via USB port.
- \* **DT105R** is to open the cash drawer when it receives the trigger command or the RTS/DTR signal control from the computer via RS232 port.

## ■ Indicators Information

### DT105X with COMMAND control

STATUS	GREEN LED	RED LED	BUZZER	COMMUNICATION
POWER ON	BLINK 2 TIMES	BLINK 2 TIMES	BEEP-BEEP	X
READY	ON	OFF	X	O
OPEN CASH DRAWER	OFF	ON	BEEP	X
COMMUNICATION	BLINK	OFF	X	X

### DT105X with RTS/DTR signal control

STATUS	GREEN LED	RED LED	BUZZER	RTS/DTR
POWER ON	BLINK 2 TIMES	BLINK 2 TIMES	BEEP-BEEP	X
READY	ON	OFF	X	H/L
X	OFF	OFF	X	L/L , H/H
OPEN CASH DRAWER	OFF	ON	BEEP	L/H

### PB105

STATUS	GREEN LED	BUZZER
READY	OFF	X
ACTION	ON	BEEP

# Connections

## WAS-1510

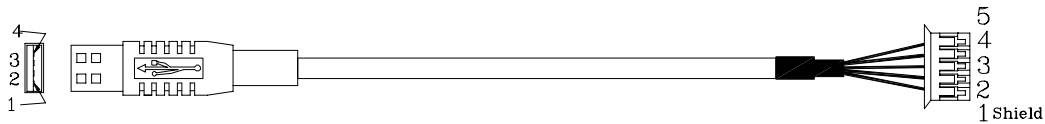

USB	COLOR	FUNCTION	5 PIN
1	RED	POWER +	5
2	WHITE	D -	4
3	GREEN	D +	3
4	BLACK	GND	2
Shell	Drain Wire	Shield	1

## WAS-1526

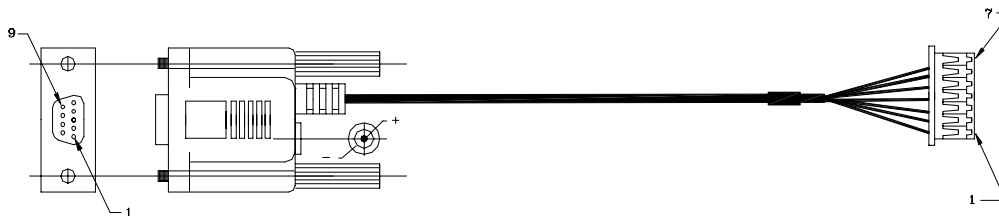

DSB 9P FEMALE *	COLOR	FUNCTION	7 PIN **
3	PURPLE	TXD	5
2	WHITE	RXD	6
4	YELLOW	DTR	2
5	BLACK	GND	4
7	BLACK	RTS	1
8	BLUE	CTS	3
POWER JACK			
+	RED	+ 5 Vdc	7
-	BLACK	GND	4

\* DSB 9P FEMALE Pin 6,7 connected together

## WAS-1528

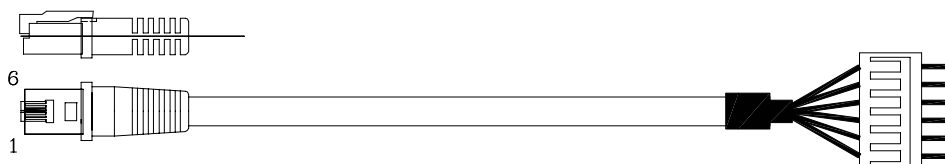

6P6C	COLOR	FUNCTION	6 PIN
1	BLACK	GND	1
2	WHITE	Sol -	2
3	RED	Status	3
4	YELLOW	Sol +	4
5	PURPLE	Sol -	5
6	BLUE	GND	6

## 6P6C Modular Jack Connector

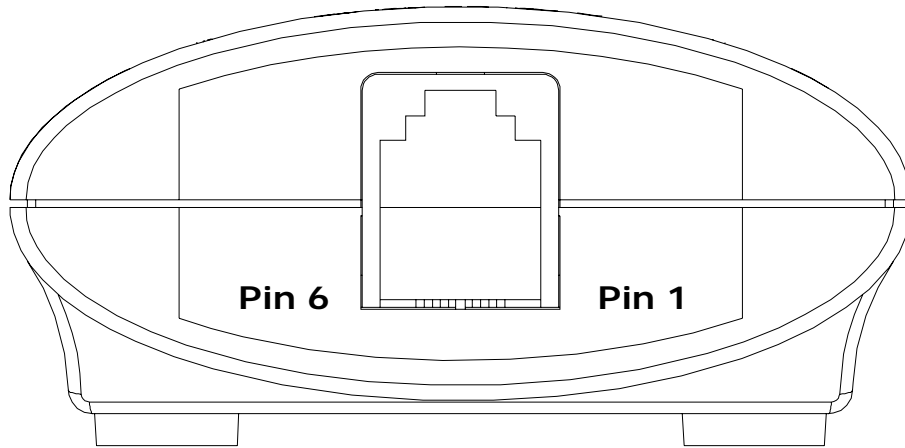

Pin Number	Function
6	GND
5	Sol - (for EPSON drawer 2)
4	Sol +
3	Status
2	Sol -
1	GND

## Application Note

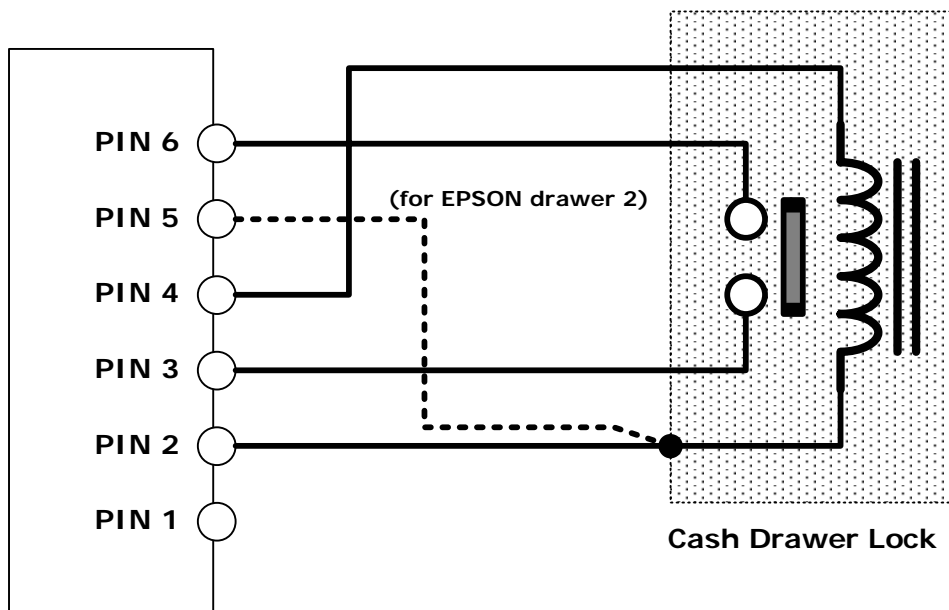

DT105U  
DT105R



# Load Test

## Load Test Circuit

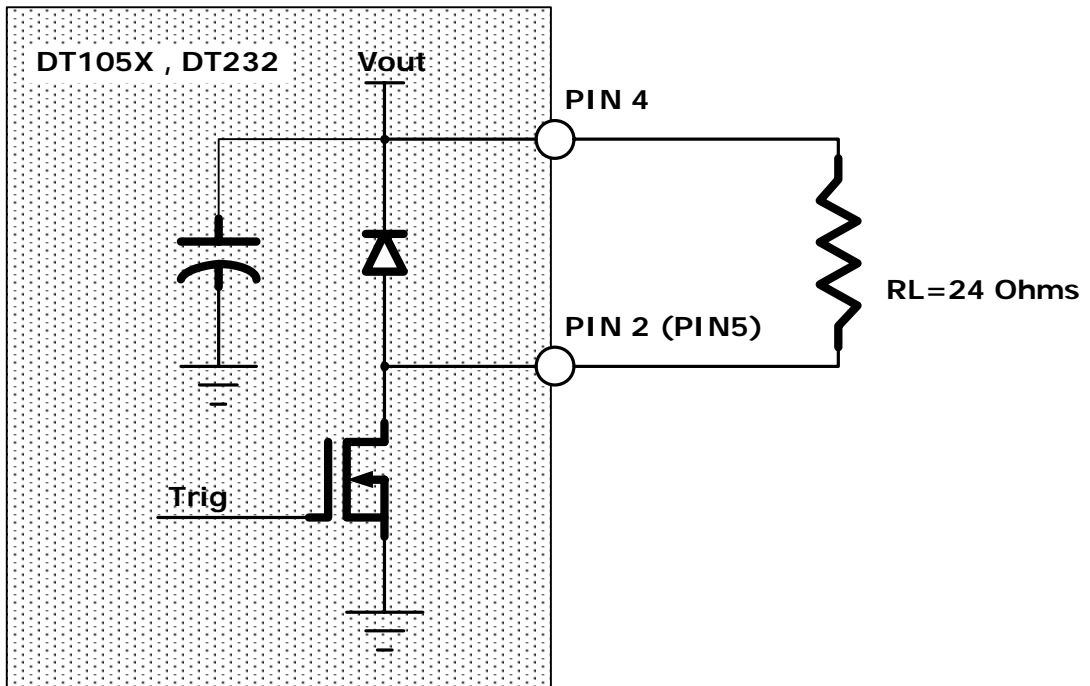

## Load Test Timing Diagram

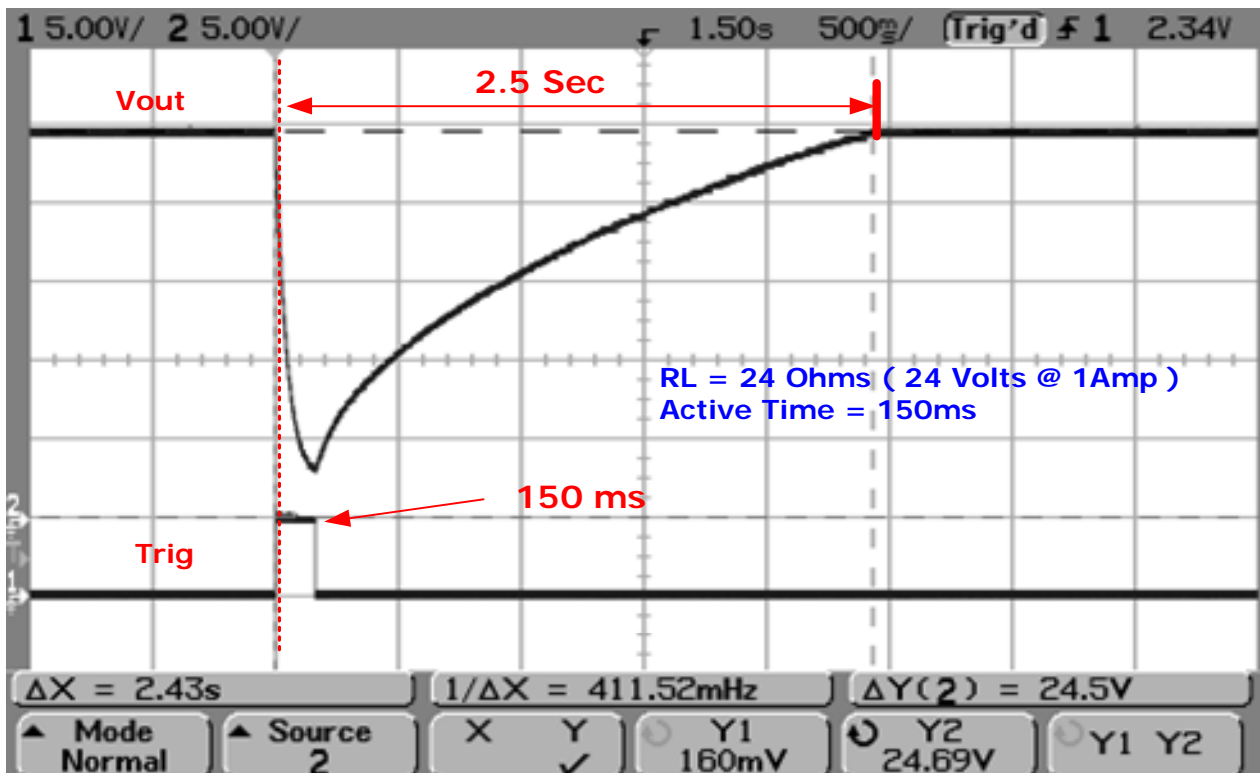

# USB Driver Setup

## Driver Software Installation - For DT105U only

1. Connect **DT105U** into the USB PORT of your Computer first.
2. Under Windows **98/2000/Me/XP**, put **DISK5140** into the cd-rom disk driver, it will automatically install the PROMAG USB232/422/485 Driver Software into your Computer by following the steps as below:

### 1. This wizard searches for new drivers for USB Device



### 2. What do you want Windows to do ?

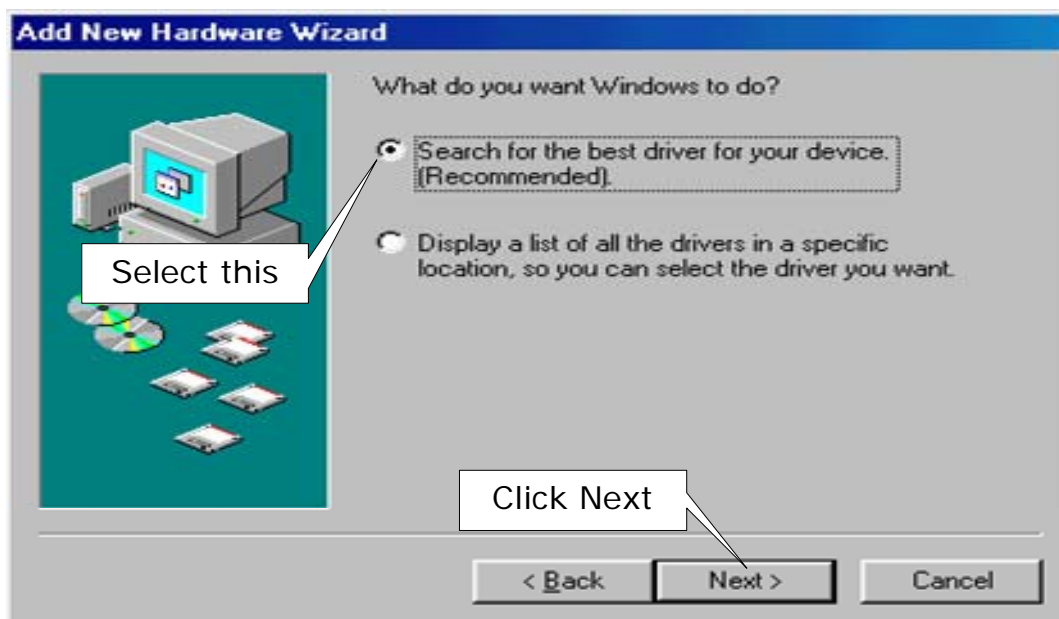

### 3. Select Searching locations for new driver

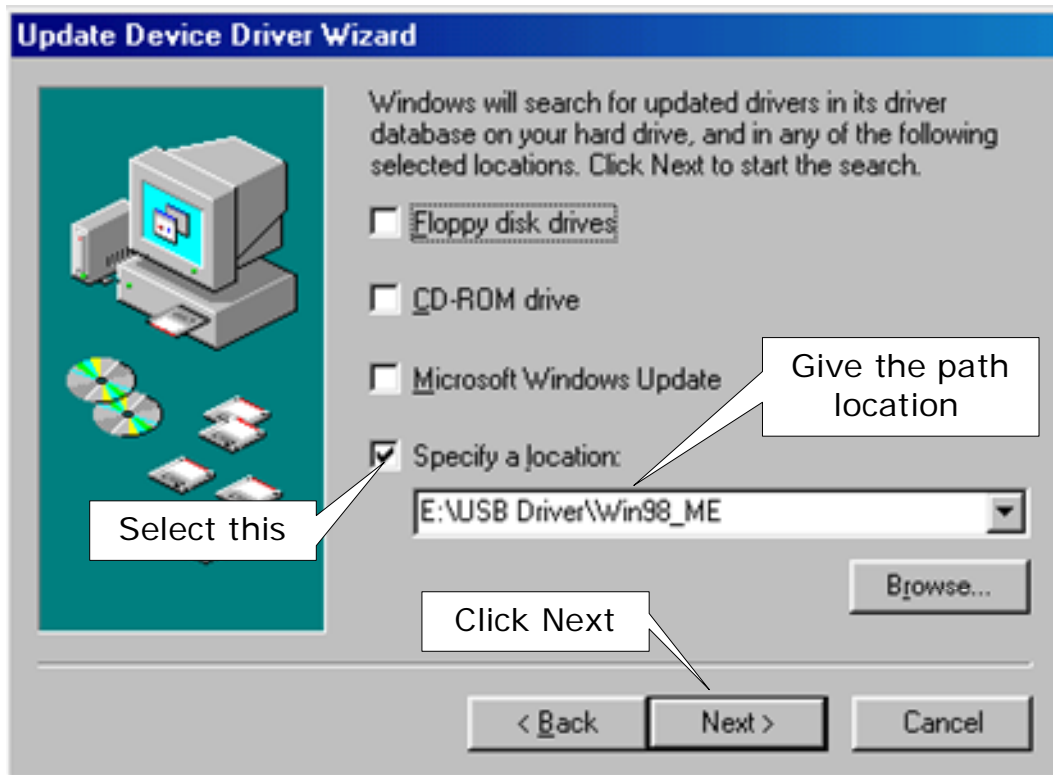

### 4. Windows is now ready to install the best driver

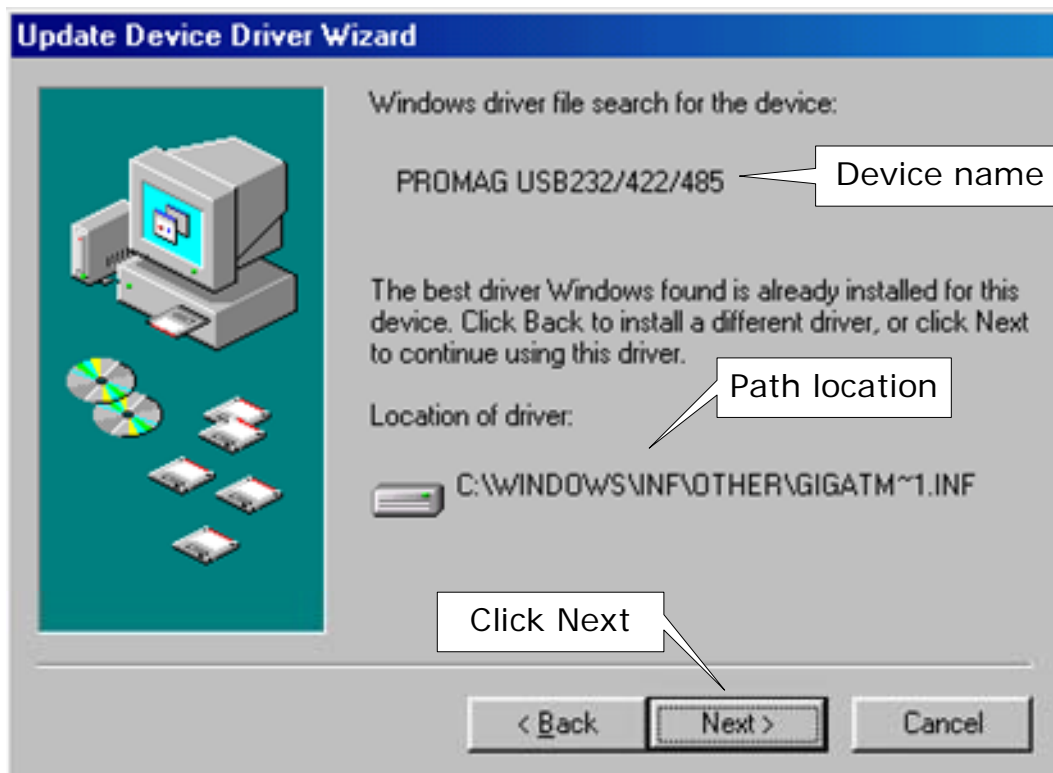

5. Windows has finished installing the software



## 6. Make sure if the driver software installation is finished

Connect DT105U unit into the USB port of the computer and then Click " Start " -> " Settings " -> " Control Panel " -> " System " -> " Device Manager " to see if there are " PROMAG USB232/422/485(COM3)" at Ports (COM & LPT) and "PROMAG USB232/422/485 "at Universal Serial Bus controllers.

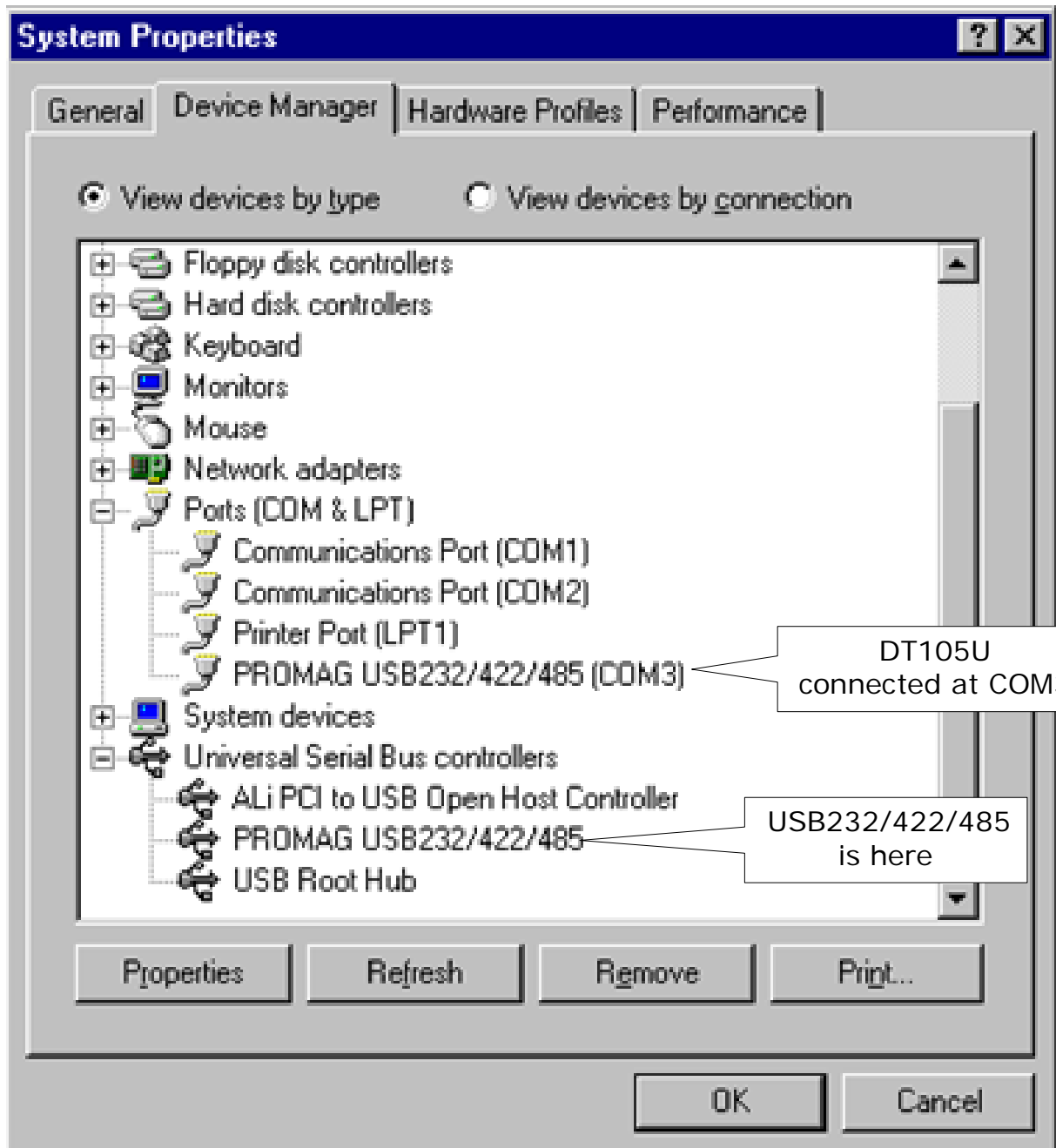

# Specifications



## USB Interface ( for DT105U )

USB V1.1 & USB HID Class V1.0

RTS ( Request To Send ) & DTR ( Data Terminal Ready ) be used



## RS232 Interface ( for DT105R )

RS232 , Half-Duplex , 8N1 , 9600 bps

RTS ( Request To Send ) & DTR ( Data Terminal Ready ) be used



## Output Power

RJ12 Connector , Rating suits 10 - 36 Ohms solenoid ( 24Volts @1Amp ), On time : 150ms, Repeat rate : 3 seconds

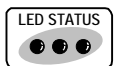

## MULT-COLOR LED Display

Green LED - Ready / Communication

Red LED - Open Cash Drawer



## Operate Sound ( for DT105U, DT105R )

3Khz , 45 dB , Built in the device

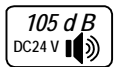

## Operate Sound ( for PB105 )

3Khz , Min 105 dB at 30cm / 24 Volts



## Power Supply ( for DT105R )

DC 5V -12V , 500mA

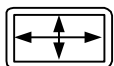

## Dimensions

D 26 x W 56 x H 85 mm

Cable Lenght - DT105U : 1650 mm

DT105R,DT232,BP105 : 1550 mm



## Weight

DT105U : 90g ( including cable )

DT105R : 110g ( including cable )

BP105 : 70g ( including cable )

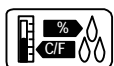

## Environment :

Operating Temp : 0 ~ 55 Deg.C

Storage Temp : -10 ~ 55 Deg.C

Humidity : 10 ~ 90 % relative

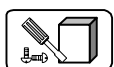

## Mounting :

Portable or Any surface

# Communication Protocol

## DT105U & DT105R Communication Protocol

### 1. CITIZEN OPEN CASH DRAWER 1

ASCII 

BEL
-----

  
 HEX 

07
----

Reply (HEX)  

14	00	00	0F
----	----	----	----

 Cash drawer close  

10	00	00	0F
----	----	----	----

 Cash drawer open

### 2. STAR OPEN CASH DRAWER 1

ASCII 

BEL
-----

 or 

FS
----

  
 HEX 

07
----

 or 

1C
----

Reply (HEX)  

14	00	00	0F
----	----	----	----

 Cash drawer close  

10	00	00	0F
----	----	----	----

 Cash drawer open

### 3. EPSON OPEN CASH DRAWER 1 AND 2

ASCII 

ESC	p	m	t1	t2
-----	---	---	----	----

  
 HEX 

1B	70	00,30 01,31	00~FF	00 ~ FF
----	----	----------------	-------	---------

Reply (HEX)  

14	00	00	0F
----	----	----	----

 Cash drawer close  

10	00	00	0F
----	----	----	----

 Cash drawer open

\* m = 00h, 30h Drawer kick-out connector pin2.  
 \* m = 01h, 31h Drawer kick-out connector pin5.  
 \* Open Cash Drawer Time = t1 \* 2 ms

PS. 1. m = 00h, 01h, 30h, 31h  
 2. t1=t2=0 ~ 255 (t1=0 not active)  
 3. t2>t1 or t2=t1

### 4. PROTOLINK OPEN CASH DRAWER 1

ASCII 

C	C		1	CR
---	---	--	---	----

  
 HEX 

43	43	20	31	0D
----	----	----	----	----

Reply (HEX)  

14	00	00	0F
----	----	----	----

 Cash drawer close  

10	00	00	0F
----	----	----	----

 Cash drawer open

### 5. PROTOLINK DUMP FIRMWARE VERSION

ASCII 

D	G		2	CR
---	---	--	---	----

  
 HEX 

44	47	20	32	0D
----	----	----	----	----

Reply (ASCII)  

(	C	)		2	0	0	2		G	I	G	A
-	T	M	S		D	T	-	1	0	5	X	
V	E	R	S	I	O	N		1	.	1	0	CR

### 6. EPSON ENABLE AUTOMATIC STATUS BACK

ASCII 

GS	a	FF
----	---	----

  
 HEX 

1D	61	FF
----	----	----

Reply (HEX)  

14	00	00	0F
----	----	----	----

 Cash drawer close  

10	00	00	0F
----	----	----	----

 Cash drawer open

7. It is also sending the status string on every open/close change of the drawer automatically.

Reply (HEX) : 

10	00	00	0F
----	----	----	----

 Cash drawer open . or 

14	00	00	0F
----	----	----	----

 Cash drawer close

## DT105U & DT105R Signal Control and Status

	PIN4 DTR RS232/TTL	PIN7 RTS RS232 / TTL	RED LED	GREEN LED	BUZZER LED	STATUS
CONTROL	+12V / L	+12V / L	OFF	OFF	OFF	X
	+12V / L	-12V / H	OFF	ON	OFF	READY
	-12V / H	+12V / L	ON	OFF	ON	OPEN
	-12V / H	-12V / H	OFF	OFF	OFF	X
STATUS	PIN8 CTS RS232/TTL	STATUS				
	+12V / L	Cash drawer open				
	-12V / H	Cash drawer close				

# Application Note

## 1. POS System For Standard Connect

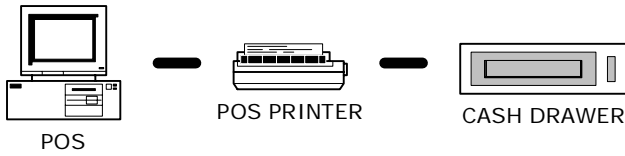

## 2. POS System For Standard Connect Plus PB105

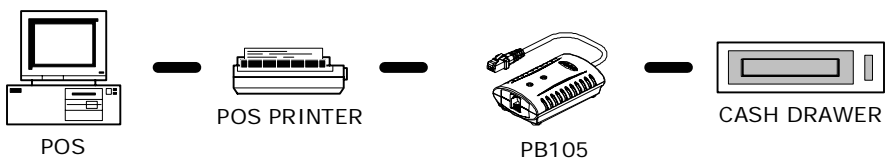

## 3. POS System Replace POS Printer By DT-105U/R

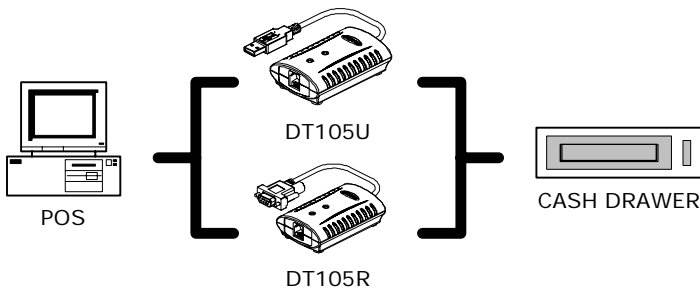

## 4. POS System Replace POS Printer By DT-105U/R Plus PB105

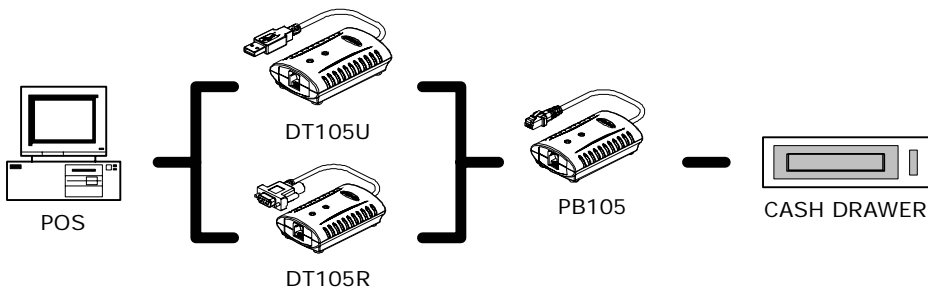

## 5. POS System Replace POS Printer By DT-105U/R Plus Two PB105

